

MEDICAL INSTRUMENTS

VASCULAR SURGERY



MEDICAL
INSTRUMENTS

MICRO SURGICAL FORCEPS

TITANIUM

Micro Forceps (straight)

Round Handle Titanium

| Length\Tips | 0,3 mm | 0,5 mm |
|--------------|--------|----------|
| 110 mm, 4,4" | F0756 | |
| 185 mm, 7,4" | | F5775 |
| 200 mm, 8" | | F0119.01 |
| 210 mm, 8,4" | | F5776 |
| 230 mm, 9,2" | | F0684 |
| 250 mm, 10" | | F5777 |

Micro Forceps with Platform (straight)

Round Handle Titanium

| Length\Tips | 0,2 mm | 0,3 mm | 0,4 mm | 0,5 mm | 0,6 mm |
|--------------|--------|----------|----------|--------|--------|
| 120 mm, 4,8" | | | | F5766 | |
| 130 mm, 5,2" | | | F4061 | | |
| 135 mm, 5,4" | F0208 | | | | |
| 150 mm, 6" | | | | F5768 | |
| 160 mm, 6,4" | | F0209 | F0209.02 | | F0604 |
| 185 mm, 7,4" | | | | F5770 | |
| 200 mm, 8" | | F0473.01 | | | |
| 210 mm, 8,4" | | | | F5771 | |
| 230 mm, 9,2" | | | | F5772 | |

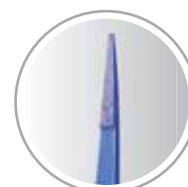
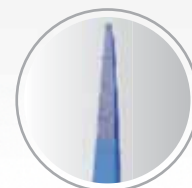

Tungsten carbide plated jaws

TITANIUM

TITANIUM

MICRO SURGICAL FORCEPS

Micro Forceps (curved)

Round Handle Titanium

| | |
|--------------|-----------|
| Length\Tips | 0,4 mm |
| 185 mm, 7,4" | F0455 |

Micro Forceps with Platform (curved)

Round Handle Titanium

| Length\Tips | 0,3 mm | 0,4 mm | 0,5 mm | 0,6 mm |
|--------------|-----------|-----------|-----------|-----------|
| 120 mm, 4,8" | | | F5767 | |
| 130 mm, 5,2" | F0212 | F4062 | | |
| 150 mm, 6" | | | F0766.01 | |
| 160 mm, 6,4" | F0301 | | | F0604.01 |
| 185 mm, 7,4" | | | F5773 | |
| 200 mm, 8" | F0473 | | | |
| 210 mm, 8,4" | | | F5774 | |
| 210 mm, 8,4" | | | F0613 | |

Micro Forceps with Platform (angled 45°)

Round Handle Titanium

| | |
|--------------|-----------|
| Length\Tips | 0,5 mm |
| 185 mm, 7,4" | F0614 |

Tungsten carbide plated jaws

TITANIUM



F0614

MICRO SURGICAL FORCEPS

Micro Forceps (curved)

Round Handle Titanium

| | |
|-------------|-----------|
| Length\Tips | 0,5 mm |
| 200 mm, 8" | F0119.02 |

Micro Forceps with Platform (curved)

Round Handle Titanium

| | |
|--------------|-----------|
| Length\Tips | 0,3 mm |
| 160 mm, 6,4" | F0118 |



F0119.02

Tungsten carbide plated jaws

TITANIUM

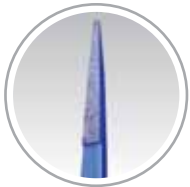

F0310.01

F0473.03
F0473.02

Micro Forceps with Platform (curved)

Round Handle Titanium

| Length\Tips | 0,3 mm | 0,4 mm |
|--------------|-----------|-----------|
| 152 mm, 6,8" | F0309 | F0309.02 |
| 180 mm, 7,2" | | F0310 |

Micro Forceps with Platform (angled 45°)

Round Handle Titanium

| Length\Tips | 0,5 mm |
|-------------|-----------|
| 152 mm, 6,8 | F0309.04 |

Micro Forceps with Platform (straight)

Round Handle Titanium

| Length\Tips | 0,3 mm | 0,4 mm |
|--------------|-----------|-----------|
| 152 mm, 6,8" | F0309.01 | F0309.03 |
| 180 mm, 7,1" | | F0310.01 |

Round Handle with limiter of opening Titanium

| Length\Tips | 0,3 mm | |
|-------------|-----------|----------|
| 200 mm, 8" | F0473.03 | straight |
| 200 mm, 8" | F0473.02 | curved |

Tungsten carbide plated jaws

TITANIUM



Convex-Concave Micro Forceps (straight)

Round Handle Titanium

| Length\Jaws | 0,3 mm | 0,4 mm | 0,5 mm |
|--------------|--------|--------|--------|
| 130 mm, 5,2" | | F4057 | |
| 135 mm, 5,4" | | | F0300 |
| 160 mm, 6,4" | F4059 | | F0299 |

Convex-Concave Micro Forceps (curved)

Round Handle Titanium

| Length\Jaws | 0,3 mm | 0,4 mm | 0,5 mm |
|--------------|--------|--------|--------|
| 130 mm, 5,2" | | F4058 | |
| 135 mm, 5,4" | | | F0302 |
| 160 mm, 6,4" | F4060 | | |



TITANIUM

MICRO SURGICAL FORCEPS

Round Handle with Counter Balance Titanium

Micro Forceps (straight)

| Length\Tips | 0,4 mm |
|--------------|--------|
| 155 mm, 6,2" | F4069 |
| 175 mm, 7" | F4071 |

Micro Forceps with Platfor (straight)

| Length\Tips | 0,4 mm | 0,5 mm | 0,6 mm | 1,5 mm |
|--------------|----------|----------|--------|--------|
| 145 mm, 5,8" | | | F0588 | |
| 150 mm, 6" | | F5716 | | |
| 155 mm, 6,2" | F4073 | | | |
| 160 mm, 6,4" | | | F0452 | |
| 175 mm, 7" | F4075 | | | |
| 185 mm, 7,4" | | F5710 | | |
| 210 mm, 8,4" | | F5711 | F0401 | F0627 |
| 230 mm, 9,2" | | F0552.02 | | |
| 250 mm, 10" | F5714.01 | F5714 | | |

Micro Forceps (curved)

| Length\Tips | 0,4 mm |
|--------------|--------|
| 155 mm ,6,2" | F4070 |
| 175 mm ,7" | F4072 |

Micro Forceps with Platform (curved)

| Length\Tips | 0,4 mm | 0,5 mm | 0,6 mm |
|--------------|--------|----------|----------|
| 150 mm, 6" | | F5717 | |
| 155 mm, 6,2" | F4074 | | |
| 160 mm, 6,4" | | | F0452.01 |
| 175 mm, 7" | F4076 | | |
| 185 mm, 7,4" | | F5712 | |
| 210 mm, 8,4" | | F5713 | F0401.01 |
| 230 mm, 9,2" | | F0690.03 | |
| 250 mm, 10" | | F5715 | |

Tungsten carbide plated jaws

TITANIUM



F4069
F4071

F5710
F5711

F5712
F5713

SURGICAL FORCEPS

TITANIUM

Surgical Forceps (straight)

Gerald Flat Handle Titanium

| Length\Tips | 0,7 mm | 1,0 mm | 1,3 mm | 2,0 mm |
|--------------|----------|----------|----------|--------|
| 175 mm, 7" | F5740.01 | F0630.03 | | |
| 185 mm, 7,4" | F5828.01 | | F5828 | |
| 210 mm, 8,4" | F5829.01 | | F5829 | |
| 230 mm, 9,2" | | | F0663.01 | F0737 |

Surgical Forceps with Platform (straight)

Gerald Flat Handle Titanium

| Length\Tips | 0,7 mm | 1,0 mm |
|--------------|----------|--------|
| 185 mm, 7,4" | F5826.01 | F5826 |
| 210 mm, 8,4" | F5827.01 | F5827 |

Surgery Forceps (straight)

Gerald Flat Handle Titanium

| Length\Tips | 0,7 mm | 1,0 mm | 1,3 mm |
|--------------|----------|----------|--------|
| 185 mm, 7,4" | F5830.01 | F5830.02 | F5830 |
| 210 mm, 8,4" | F5831.01 | | F5831 |

Platform Forceps (straight)

Flat Handle Titanium

| Length\Tips | 1,0 mm |
|--------------|--------|
| 180 mm, 7,2" | F0537 |

Tungsten carbide plated jaws

TITANIUM



F5826
F5827
F5828
F5829

F5830
F5831

F0537

Jeweler Forceps

Flat Handle Titanium

| Length\Tips | 0,25 mm | 0,3 mm | |
|--------------|---------|----------|----------|
| 120 mm, 4,8" | F0433 | | curved |
| 120 mm, 4,8" | | F0284 | straight |
| 135 mm, 5,4" | | F0284.01 | straight |
| 135 mm, 5,4" | F0333 | | curved |

Jeweler Forceps with Platform

Flat Handle Titanium

| Length\Tips | 0,25 mm | 0,3 mm | 0,4 mm | |
|--------------|----------|----------|----------|----------|
| 120 mm, 4,8" | | | F0433.01 | curved |
| 135 mm, 5,4" | | F0284.02 | | straight |
| 135 mm, 5,4" | F0333.01 | | | curved |



Tungsten carbide plated jaws

TITANIUM

SURGICAL FORCEPS

Surgical Forceps

Adson Flat Handle Titanium

| Length\Tips | 0,2 mm | |
|--------------|--------|----------|
| 145 mm, 7,4" | F0103 | straight |

Surgical Forceps with Platform

Adson Flat Handle Titanium

| Length\Tips | 0,3 mm | |
|--------------|--------|----------|
| 130 mm, 5,2" | F0104 | straight |
| 130 mm, 5,2" | F0106 | curved |



Tungsten carbide plated jaws

TITANIUM

Double-Action Forceps with Platform (streight)



| Length\Tips | 0,5 mm | 0,65 mm |
|---------------|--------|---------|
| 185 mm, 7,4" | F6082 | F0662 |
| 210 mm, 8,4" | F6081 | |
| 250 mm, 10" | F6081 | |
| 305 mm, 12,2" | F6085 | |

Double-Action Forceps with Platform (curved)

| Length\Tips | 0,5 mm |
|---------------|--------|
| 185 mm, 7,4" | F6092 |
| 210 mm, 8,4" | F6091 |
| 250 mm, 10" | F6090 |
| 305 mm, 12,2" | F6095 |

Tungsten carbide plated jaws

TITANIUM

BAYONET FORCEPS

TITANIUM

Forceps (straight)

Bayonet Flat Handle Titanium

| Length\Tips | 0,25 mm | 0,5 mm |
|---------------|---------|--------|
| 215 mm, 8,6" | F3000 | F3020 |
| 260 mm, 10,4" | | F3030 |

| Length\Tips | 0,75 mm | 1,0 mm |
|---------------|---------|----------|
| 160 mm, 6,4" | | F0617.01 |
| 215 mm, 8,6" | F0347 | F3060 |
| 250 mm, 10" | F3040 | |
| 260 mm, 10,4" | | F3070 |

| Length\Tips | 1,5 mm |
|---------------|--------|
| 215 mm, 8,6" | F3080 |
| 260 mm, 10,4" | F3090 |

| Length\Tips | 0,5 mm | angled |
|--------------|--------|-----------|
| 215 mm, 8,6" | F3022 | 30 ° up |
| 215 mm, 8,6" | F3024 | 30 ° down |

| Length\Tips | 0,75 mm | angled |
|--------------|---------|-----------|
| 215 mm, 8,6" | F3046 | 90 ° up |
| 215 mm, 8,6" | F3048 | 90 ° down |



F3020

F3046

F3024

Tungsten carbide plated jaws

TITANIUM

Micro Forceps with Platform (straight)

Bayonet Flat Handle Titanium

| Length\Tips | 0,5 mm |
|--------------|----------|
| 200 mm, 8" | F0125.02 |
| 220 mm, 8,8" | F0125.03 |
| 230 mm, 9,2" | F0605 |

Bayonet Flat Handle with holes Titanium

| Length\Tips | 0,6 mm |
|--------------|----------|
| 200 mm, 8" | F0765 |
| 220 mm, 8,8" | F0765.01 |

Micro Forceps (straight)

Round Bayonet Handle Titanium

| Length\Tips | 0,5 mm | 1,0 mm |
|--------------|--------|--------|
| 215 mm, 8,6" | | F3260 |
| 215 mm, 8,6" | F3220 | |



F3220

F0125.02

F0765
F0765.01

Tungsten carbide plated jaws

TITANIUM

BAYONET FORCEPS

TITANIUM

Flat Handle Titanium

DeBakey Tissue Forceps (straight)

| Length\Jaws | 1,0 mm | 1,5 mm | 2,0 mm |
|---------------|----------|--------|--------|
| 130 mm, 5,1" | | F0454 | |
| 150 mm, 5,9" | F0429.01 | F5800 | F0429 |
| 175 mm, 6,8" | F0630.01 | | |
| 185 mm, 7,25" | F0463 | F0597 | |
| 200 mm, 8" | F0430.01 | F5801 | F0430 |
| 210 mm, 8,25" | | F5812 | |
| 240 mm, 9,4" | F0431.01 | F5802 | F0431 |
| 300 mm, 12" | F0488.01 | F5814 | F0488 |

| Length\Jaws | 2,5 mm | 2,9 mm | 3,5 mm | 4,0 mm |
|---------------|--------|----------|--------|----------|
| 150 mm, 5,9" | FL5803 | F0429.02 | | |
| 200 mm, 8" | FL5804 | F0430.02 | F0628 | |
| 210 mm, 8,25" | FL5813 | | | |
| 240 mm, 9,4" | FL5805 | F0431.02 | | |
| 300 mm, 12" | | F0488.02 | | F0488.03 |

DeBakey Tissue Forceps (angled 45°)

| Length\Jaws | 1,0 mm | 2,0 mm | 2,5 mm |
|--------------|--------|----------|--------|
| 150 mm, 6" | | F0429.03 | F5809 |
| 200 mm, 8" | | F0430.03 | |
| 240 mm, 9,4" | F5810 | | F5811 |



TITANIUM

ATRAUMATIC FORCEPS

DeBakey Tissue Forceps (straight)

Gerald Flat Handle Titanium

| Length\Tips | 1,0 mm | 1,5 mm | 3,5 mm |
|---------------|-----------|-----------|-----------|
| 150 mm, 5,9" | F5822 | | |
| 185 mm, 7,25" | | F5820 | |
| 210 mm, 8,25" | F5821 | | |
| 230 mm, 9,25" | F0629.01 | | |
| 240 mm, 9,4" | | | F0487 |

DeBakey Tissue Forceps (curved)

Gerald Flat Handle Titanium

| Length\Tips | 1,0 mm |
|---------------|-----------|
| 210 mm, 8,25" | F5821.01 |

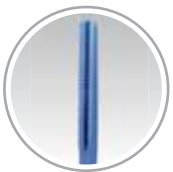

ATRAUMATIC FORCEPS

TITANIUM

DeBakey Tissue Forceps (straight)

Round Handle Titanium

| Length\Jaws | 1,0 mm | 1,4 mm | 3,5 mm |
|---------------|--------|--------|--------|
| 120 mm, 4,7" | F0692 | | |
| 150 mm, 5,9" | | F0100 | |
| 160 mm, 6,2" | F0609 | | F0611 |
| 185 mm, 7,25" | F5780 | | |
| 200 mm, 8" | | F0165 | |
| 210 mm, 8,25" | F5781 | | |
| 250 mm, 10" | F5782 | | |

DeBakey Tissue Forceps (curved)

Round Handle Titanium

| Length\Jaws | 1,0 mm |
|---------------|----------|
| 160 mm, 6,2" | F0453.01 |
| 185 mm, 7,25" | F0387.02 |

DeBakey Needle Pulling and Tissue Forceps (straight)

Round Handle Titanium

| Length\Jaws | 1,0 mm |
|---------------|----------|
| 150 mm, 5,9" | F0672 |
| 160 mm, 6,2" | F0453.01 |
| 185 mm, 7,25" | F0673 |
| 210 mm, 8,25" | F0674 |

Tungsten carbide plated jaws

TITANIUM

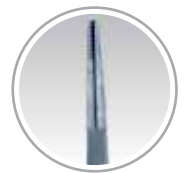
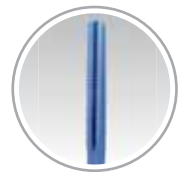

DeBakey Tissue Forceps (straight)

Round Handle with Counter Balance Titanium

| Length\Jaws | 1,0 mm | 1,1 mm | 1,5 mm | 3,5 mm |
|---------------|--------|----------|--------|--------|
| 160 mm, 6,2" | F0453 | | | F0528 |
| 185 mm, 7,25" | F5722 | | | |
| 210 mm, 8,25" | F0402 | F0728.01 | F1022 | F0483 |
| 230 mm, 9,25" | F0552 | F0760.02 | | |
| 250 mm, 10" | F5720 | F0760.03 | | |

DeBakey Needle Pulling and Tissue Forceps (straight)

Round Handle with Counter Balance Titanium

| Length\Jaws | 1,0 mm |
|---------------|----------|
| 150 mm, 5,9" | F0671 |
| 185 mm, 7,25" | F5724 |
| 210 mm, 8,25" | F5723 |
| 230 mm, 9,25" | F0689.02 |
| 250 mm, 10" | F0689.03 |

Tungsten carbide plated jaws

TITANIUM

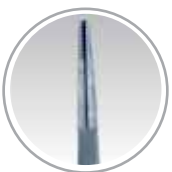
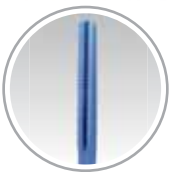

ATRAUMATIC FORCEPS

TITANIUM

Double-Action DeBakey Forceps (straight)

Round Handle with Counter Balance Titanium

| Length\Jaws | 1,0 mm | 1,5 mm | 2,5 mm |
|---------------|--------|--------|--------|
| 185 mm, 7,25" | F6022 | F6172 | F6032 |
| 210 mm, 8,25" | F6021 | F6171 | F6031 |
| 250 mm, 10" | F6020 | F6170 | F6030 |
| 305 mm, 12" | F6024 | | F6034 |

Double-Action DeBakey Needle Pulling and Tissue Forceps (straight)

Round Handle with Counter Balance Titanium

| Length\Jaws | 1,0 mm | 2,5 mm |
|---------------|--------|--------|
| 185 mm, 7,25" | F6042 | |
| 210 mm, 8,25" | F6041 | |
| 250 mm, 10" | F6040 | |
| 305 mm, 12" | F6044 | F6038 |

Double-Action DeBakey Needle Pulling and Tissue Forceps (straight)

Round Handle with Counter Balance Titanium

| Length\Jaws | 1,0 mm | 2,5 mm |
|-------------|--------|--------|
| 250 mm, 10" | F6050 | F6060 |

Tungsten carbide plated jaws

TITANIUM

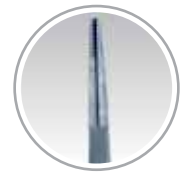
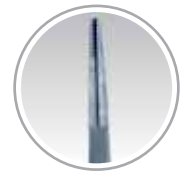
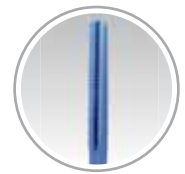

Resano Vascular Forceps (straight)

Flat Handle Titanium

| Length\Tips | 2,0 mm |
|----------------|-----------|
| 185 mm, 7,25" | F5832 |
| 210 mm, 8,25" | F5835 |
| 240 mm, 9,4" | F5833 |
| 320 mm, 12,75" | F5834 |

Resano Double-Action Vascular Forceps (straight)

Round Handle with Counter Balance Titanium

| Length\Tips | 2,0 mm |
|---------------|-----------|
| 210 mm, 8,25" | F6071 |
| 250 mm, 10" | F6070 |
| 305 mm, 12" | F6074 |

Cooly Tissue Forceps (straight)

Flat Handle Titanium

| Length\Tips | 2,0 mm |
|--------------|-----------|
| 150 mm, 5,9" | F5836 |
| 200 mm, 8" | F5837 |
| 240 mm, 9,4" | F5838 |
| 300 mm, 12" | F5839 |

Tungsten carbide plated jaws

TITANIUM

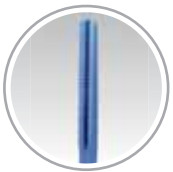
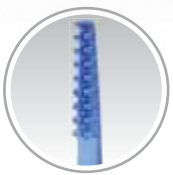

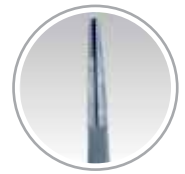
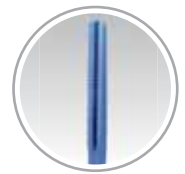

ATRAUMATIC FORCEPS

DeBakey Tissue Forceps (straight)

Bayonet Flat Handle Titanium

| | |
|-------------|--------|
| Length\Jaws | 1,4 mm |
| 200 mm, 8" | F0121 |

| | | |
|--------------|--------|--------|
| Length\Jaws | 1,0 mm | 1,4 mm |
| 215 mm, 8,5" | F3821 | |
| 220 mm, 8,5" | | F0124 |



F3821
F3823

F0124

F0121

DeBakey Needle Pulling and Tissue Forceps (straight)

Bayonet Flat Handle Titanium

| | |
|--------------|--------|
| Length\Jaws | 1,0 mm |
| 215 mm, 8,5" | F3823 |

Tungsten carbide plated jaws

TITANIUM

DeBakey Tissue Forceps (straight)

Bayonet Flat Handle with holes Titanium

| Length\Jaws | 1,4 mm |
|--------------|--------|
| 200 mm, 8" | F0762 |
| 220 mm, 8,6" | F0764 |



F0762

F0764

SURGICAL FORCEPS

TITANIUM

1x2 Teeth Forceps (straight)

Round Handle Titanium

| Length\Tooth | 0,2 mm |
|---------------|--------|
| 160 mm, 6,25" | F0575 |

Round Handle Titanium

| Length\Tooth | 0,07 mm |
|---------------|---------|
| 185 mm, 7,25" | F5731 |
| 210 mm, 8,25" | F5732 |

| Length\Tooth | 0,4 mm |
|---------------|--------|
| 180 mm, 7,25" | F0456 |
| 200 mm, 8" | F0119 |

2x3 teeth forceps with tying platform (straight)

Round Handle Titanium

| Length\Tooth | 0,4 mm |
|--------------|----------|
| 200 mm, 8" | F0119.04 |

Tungsten carbide plated jaws

TITANIUM

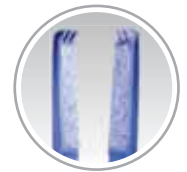
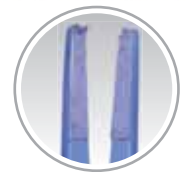
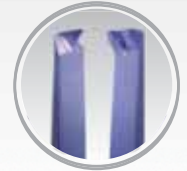

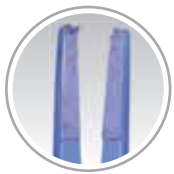
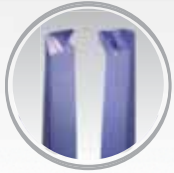

Forceps with teeth on tips (straight)

Round Handle with Counter Balance Titanium

| Length\Tooth | 0,25 mm Width 0,5 mm | 0,25 mm Width 1 mm |
|---------------|----------------------------|--------------------------|
| 130 mm, 2,25" | F0480 | |
| 185 mm, 7,25" | | F5735 |
| 210 mm, 8,25" | | F5736 |

1x2 teeth forceps with tying platform (straight)

Round Handle with Counter Balance Titanium

| Length\Tooth | 0,25 mm | 0,4 mm | 0,6 mm | 0,8 mm |
|---------------|------------|-----------|-----------|-----------|
| 150 mm, 6" | | F0529 | F0529.01 | |
| 185 mm, 7,25" | F5733 | | | |
| 210 mm, 8,25" | F5734 | | | F0598 |

1x2 teeth forceps with tying platform (curved)

Round Handle with Counter Balance Titanium

| Length\Tooth | 0,25 mm Width 0,5 mm | 0,25 mm Width 1 mm | |
|---------------|-------------------------------|-----------------------------|-------------|
| 210 mm, 8,25" | FL1072.21 | | curved |
| 210 mm, 8,25" | FL1077.21 | F5735 | angled 45 ° |

Tungsten carbide plated jaws

TITANIUM

SURGICAL FORCEPS

TITANIUM

Double-Action 1x2 Teeth Forceps (straight)

Round Handle with Counter Balance Titanium

| Length\Tooth | 0,5 mm | 1,0 mm |
|---------------|--------|--------|
| 210 mm, 8,25" | F6101 | F6131 |
| 250 mm, 10" | F6100 | F6130 |

Double-Action 1x2 Teeth Forceps (angled 45°)

Round Handle with Counter Balance Titanium

| Length\Tooth | 0,5 mm | 1,0 mm |
|---------------|--------|--------|
| 210 mm, 8,25" | F6121 | F6151 |
| 250 mm, 10" | F6120 | F6150 |



Tungsten carbide plated jaws

TITANIUM

Forceps with 1x2 teeth on tips (straight)

Flat Handle Titanium

| Length\Tooth | 0,5 mm | 1,0 mm | 1,2 mm | 1,5 mm |
|---------------|----------|--------|--------|--------|
| 145 mm, 5,75" | | F0620 | F0533 | |
| 160 mm, 6,3" | F0754.01 | | | |
| 180 mm, 7,2" | | | F5785 | |
| 205 mm, 8,2" | | | | F0621 |

Forceps with 1x2 teeth on tips, with tying platform (straight)

Flat Handle Titanium

| Length\Tooth | 0,25 mm |
|--------------|---------|
| 160 mm, 6,3" | F0801 |

Forceps with 2x3 teeth on tips with crisscross serrated platform (straight)

Flat Handle Titanium

| Length\Tooth | 0,45 mm |
|--------------|---------|
| 205 mm, 8,2" | F5748 |

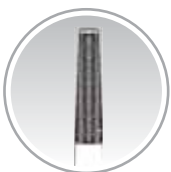
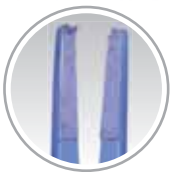
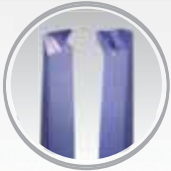

Tungsten carbide plated jaws

TITANIUM

SURGICAL FORCEPS

TITANIUM

Forceps with 1x2 micro teeth angled at 60° (straight)

Adson Flat Handle Titanium

| Length\Tooth | 0,1 mm | 0,25 mm |
|---------------|----------|---------|
| 120 mm, 4,75" | F0571.01 | F0025 |
| 130 mm, 5,2" | | F0107 |

Forceps with 1x2 micro teeth angled at 90° (straight)

Adson Flat Handle Titanium

| Length\Tooth | 0,25 mm | 0,4 mm | 0,5 mm | 0,7 mm |
|---------------|----------|--------|----------|--------|
| 120 mm, 4,75" | | | | F0758 |
| 130 mm, 5,2" | F0107.04 | | | |
| 145 mm, 5,75" | | F0105 | F0105.04 | |

Forceps with 1x2 teeth angled at 90°, with tying platform (straight)

Adson Flat Handle Titanium

| Length\Tooth | 0,4 mm | 0,7 mm | 0,85 mm |
|---------------|----------|----------|---------|
| 120 mm, 4,75" | F0025.02 | F0025.01 | F0412 |



120 mm



130 mm
145 mm

Tungsten carbide plated jaws

TITANIUM

TITANIUM

SURGICAL FORCEPS

Forceps with 1x2 Teeth on tips (straight)

Gerald Flat Handle Titanium

| | |
|--------------|---------|
| Length\Tooth | 0,95 mm |
| 175 mm, 7" | F5742 |

Forceps with crisscross serration on tips, (straight)

Gerald Flat Handle Titanium

| | |
|---------------|-------|
| Length\Tooth | 1 mm |
| 195 mm, 7,75" | F5739 |

Forceps with serrated tips (straight)

Gerald Flat Handle Titanium

| Length\Tooth | 1,0 mm | 1,5 mm | 2,0 mm |
|---------------|--------|--------|--------|
| 175 mm, 7" | F5740 | | |
| 210 mm, 8,25" | F5737 | | |
| 250 mm, 10" | F5817 | | |
| 305 mm, 12" | | F5818 | |
| 355 mm, 14" | | | F5819 |

Forceps with serrated tips (straight)

Flat Handle Titanium

| Length\Tooth | 1,0 mm | 1,5 mm | 1,7 mm | 4 mm |
|---------------|--------|--------|--------|------|
| 145 mm, 5,75" | | F0534 | | |
| 150 mm, 6" | F0569 | | | |

Tungsten carbide plated jaws

TITANIUM

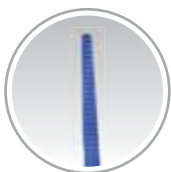
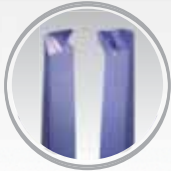

F5740
F5737
F5817

F0534

SURGICAL FORCEPS

TITANIUM

Forceps with serrated tips (straight)

Round Handle Titanium

| Length\Tooth | 1,0 mm | 1,5 mm |
|---------------|----------|----------|
| 180 mm, 7,25" | F0723.01 | |
| 200 mm, 8" | F0119.03 | F0164.01 |
| 240 mm, 9,5" | | F0661.01 |

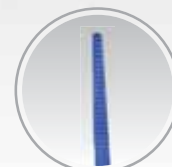

Forceps with serrated tips (straight)

Round Handle with Counter Balance Titanium

| Length\Tooth | 1,1 mm |
|---------------|--------|
| 185 mm, 7,25" | F1030 |



Pierse type forceps with groove (straight)

Round Handle with Counter Balance Titanium

| Length\Tooth | 0,4 mm |
|---------------|--------|
| 185 mm, 7,25" | F1040 |



F1030

F0723.01
F0119.03

TITANIUM

Forceps with serrated tips (straight)

Adson Flat Handle Titanium

| Length\Tooth | 1,0 mm |
|---------------|--------|
| 120 mm, 4,75" | F0024 |
| 130 mm, 5,25" | F0101 |

Forceps with serration and grooved tip (straight)

Adson Flat Handle Titanium

| Length\Tooth | 2,0 mm |
|---------------|--------|
| 120 mm, 4,75" | F0026 |
| 130 mm, 5,25" | F0102 |

Forceps with 1x2 teeth 0,7 mm high tips, with crisscross serrated platform (straight)

Adson Flat Handle Titanium

| Length\Tooth | 1,0 mm | 1,3 mm |
|---------------|----------|--------|
| 120 mm, 4,75" | F0024.01 | |
| 120 mm, 4,75" | | F0411 |

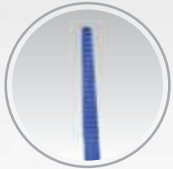

120 mm



130 mm
145 mm

SURGICAL FORCEPS

TITANIUM

Forceps with 1x2 teeth tips (straight)

Bayonet Flat Handle Titanium

| Length\Tooth | 0,3 mm | 0,5 mm |
|--------------|--------|--------|
| 162 mm, 6,4" | | F0540 |
| 200 mm, 8" | F0122 | |

| Length\Tooth | 0,7 mm | 1 mm |
|--------------|----------|-------|
| 160 mm, 6,3" | | F0617 |
| 200 mm, 8" | F0427.02 | |

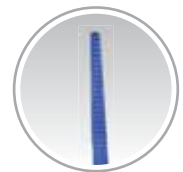
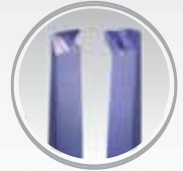

Serrated tip forceps (straight)

Bayonet Flat Handle Titanium

| Length\Tooth | 0,6 mm | 1,8 mm | 2,1 mm |
|--------------|----------|--------|--------|
| 140 mm, 5,5" | F0466 | F0465 | |
| 162 mm, 6,4" | | | F0470 |
| 220 mm, 8,8" | F0426.02 | | |



F0466

F0617
F0540
F0465
F0470

F0122
F0527.02
F0426.02

Tungsten carbide plated jaws

TITANIUM



Forceps with 1x2 micro teeth tip, with tying platform (straight)

Bayonet Flat Handle Titanium

| | |
|--------------|-----------|
| Length\Tooth | 0,1 mm |
| 215 mm, 8,5" | F3050 |



F3230

F3050

Forceps with 1x2 teeth tip, with tying platform (straight)

Bayonet Round Handle Titanium

| | |
|---------------|------------|
| Length\Tooth | 0,25 mm |
| 210 mm, 8,25" | F3230 |

Tungsten carbide plated jaws

TITANIUM

SURGICAL FORCEPS

TITANIUM

Forceps with 1x2 teeth tip (straight)

Bayonet Flat Handle with holes Titanium

| Length\Tooth | 0,4 mm | 0,75 mm |
|--------------|--------|----------|
| 200 mm, 8" | | F0427.03 |
| 240 mm, 9,5" | F0726 | |

Forceps with 1x2 teeth tip, with tying platform (straight)

Bayonet Flat Handle with holes Titanium

| Length\Tooth | 0,4 mm |
|----------------|--------|
| 260 mm, 10,25" | F0771 |

Forceps with 2x3 teeth tip, with tying platform (straight)

Bayonet Flat Handle with holes Titanium

| Length\Tooth | 0,3 mm |
|--------------|--------|
| 200 mm, 8" | F0763 |

Serrated tip forceps (straight)

Bayonet Flat Handle with holes Titanium

| Length\Tooth | 0,7 mm |
|--------------|----------|
| 220 mm, 8,8" | F0426.02 |
| 220 mm, 8,8" | F0426.03 |

Tungsten carbide plated jaws

TITANIUM



130 mm
145 mm

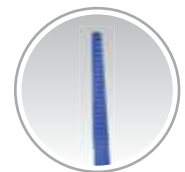
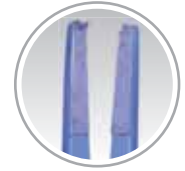
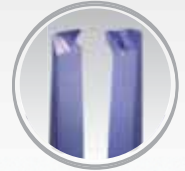

Forceps with 1x2 teeth tip, with tying platform (straight)

Bayonet Flat Handle with dissecting tip-heel Titanium

| Length\Tooth | |
|---------------|-------|
| 185 mm, 7,25" | F9111 |

Serrated tip forceps (straight)

Bayonet Flat Handle with dissecting tip-heel Titanium

| Length\Tooth | 2,0 mm |
|---------------|--------|
| 185 mm, 7,25" | F9110 |

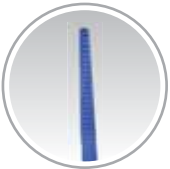

Tungsten carbide plated jaws

TITANIUM

SURGICAL FORCEPS

TITANIUM

Forceps for tumor removal

Bayonet Flat Handle Titanium

| Length\Rings | Ø 4,0 mm | Ø 6,0 mm | Ø 7,0 mm |
|--------------|----------|----------|----------|
| 200 mm, 8" | | | F0123.02 |
| 220 mm, 8,6" | F0123 | F0123.01 | |

Forceps for tumor removal

Bayonet Flat Handle Titanium

| Length\Rings | Ø 4,0 mm |
|--------------|----------|
| 215 mm, 8,5" | F3348 |



F0123



F0123.01



F0123.02



F3348

TITANIUM

TITANIUM

SURGICAL FORCEPS

Forceps for tumor removal

Bayonet Flat Handle with holes Titanium

| Length\Rings | Ø 3,0 mm | Ø 5,0 mm |
|--------------|----------|----------|
| 220 mm, 8,6" | F0622.01 | F0622 |

Forceps for tumor removal

Bayonet Flat Handle Titanium

| Length\Rings | Ø 3,0 mm | Ø 4,0 mm |
|--------------|----------|----------|
| 220 mm, 8,6" | F0786 | F0786.01 |



F0622.01
F0622

F0786
F0786.01

TITANIUM

SURGICAL FORCEPS

TITANIUM

Forceps for tumor removal

Bayonet Flat Handle with holes Titanium

| Length\Rings | 4x2,5 mm | 5x3,5 mm |
|--------------|----------|----------|
| 205 mm, 8,2" | F0425.10 | F0425.11 |
| 220 mm, 8,6" | F0425.14 | F0425.15 |

Forceps for tumor removal

Bayonet Flat Handle Titanium

| Length\Rings | 4x2,5 mm | 5x3,5 mm |
|--------------|----------|----------|
| 205 mm, 8,2" | F0425.08 | F0425.09 |
| 220 mm, 8,6" | F0425.12 | F0425.13 |

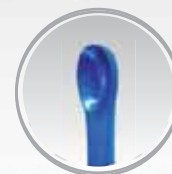

4x2,5



5x3,5

TITANIUM

TITANIUM

SURGICAL FORCEPS

Forceps
for hypophysis



F9051

F9052

F9050

| Length\Rings | |
|--------------|-------|
| 230 mm, 9,2" | F9050 |
| 222 mm, 8,8" | F9051 |
| 222 mm, 8,8" | F9052 |

Micro Vascular Delicate Fine Needle Holders

Round Handle Titanium

| Length \ Tips | 0,3 mm | 0,6 mm | |
|---------------|-----------|-----------|----------|
| 145 mm, 5,75" | H0067 | H0066 | straight |
| 145 mm, 5,75" | H0067.01 | H0066.01 | curved |
| 200 mm, 8" | H0069 | | curved |
| 200 mm, 8" | H0069.01 | | straight |

Codes are given for manufacturing without the lock,

Example: H0151.06

For manufacturing with "Universal" lock add letter "U" to the code,

Example: H0151.06U

Micro Vascular Needle Holders, Delicate "Duck's nose"

Round Handle Titanium

| Length \ Tips | 0,25 mm | 0,4 mm | Without lock |
|---------------|------------|-----------|-----------------|
| 135 mm, 5,5" | | HD4010 | straight |
| 135 mm, 5,5" | | HD4011 | curved |
| 160 mm, 6,25" | H0137 | | curved |

| Length \ Tips | 0,5 mm | 0,6 mm | Without lock |
|---------------|-----------|-----------|-----------------|
| 150 mm, 6" | HD0019 | | straight |
| 150 mm, 6" | HD0020 | | curved |
| 160 mm, 6,25" | | HD4020 | straight |
| 160 mm, 6,25" | | HD4021 | curved |
| 185 mm, 7,25" | HD0012 | | straight |
| 185 mm, 7,25" | HD0013 | H0120 | curved |
| 210 mm, 8,25" | HD0017 | | curved |

Manufactured without lock

Tungsten carbide plated jaws

TITANIUM

DELICATE NEEDLE HOLDERS

TITANIUM

Micro Vascular Delicate Needle Holders

Round Handle Titanium

| Length\Tips | 0,3 mm | 0,5 mm | |
|---------------|----------|---------------------|----------|
| 125 mm, 5" | | HD0740 | straight |
| 125 mm, 5" | | HD0741 | curved |
| 145 mm, 5,75" | | HD0744 | straight |
| 145 mm, 5,75 | | HD0745 | curved |
| 165 mm, 6,5" | H0070.01 | HD0710 | straight |
| 165 mm, 6,5" | H0070 | HD0711 | curved |
| 180 mm, 7,25" | H0073.01 | | straight |
| 180 mm, 7,25" | H0073 | | curved |
| 200 mm, 8" | | H0265.01 Twisted | straight |

| Length\Tips | 0,6 mm | 0,7 mm | |
|---------------|----------|---------------------|----------|
| 135 mm, 5,5" | HD4018 | | straight |
| 135 mm, 5,5" | HD4019 | | curved |
| 165 mm, 6,5" | | H0151.06 | straight |
| 165 mm, 6,5" | | H0151.07 | curved |
| 175 mm, 7" | H0131.01 | | straight |
| 210 mm, 7,25" | HD0712 | H0146.06 | straight |
| 210 mm, 7,25" | HD0713 | H0146.07 | curved |
| 200 mm, 8" | H0172 | | curved |
| 200 mm, 8" | H0172.01 | | straight |
| 210 mm, 8,25" | HD0714 | | straight |
| 210 mm, 8,25" | HD0715 | | curved |
| 230 mm, 9,25" | | H0275.01 Twisted | straight |
| 230 mm, 9,25" | HD0717 | | curved |
| 250 mm, 10" | HD0720 | | straight |
| 250 mm, 10" | HD0750 | | curved |
| 305 mm, 12" | HD0718 | | straight |
| 305 mm, 12" | HD0719 | | curved |



H0265.01



Codes are given for manufacturing without the lock,

Example: H0151.06

For manufacturing with lock add letter "L" to the code, Example: H0151.06L

For manufacturing with "Universal" lock add letter "U" to the code,

Example: H0151.06U

Tungsten carbide plated jaws

TITANIUM

Regular Vascular Needle Holders

Round Handle Titanium

| Length\Tips | 0,8 mm | 1 mm | |
|---------------|-----------|---------------------------|----------|
| 125 mm, 5" | | HR0740 | straight |
| 125 mm, 5" | | HR0741 | curved |
| 145 mm, 5,75" | | HR0744 | straight |
| 145 mm, 5,75" | | HR0745 | curved |
| 165 mm, 6,75" | H0177 | H0151 | straight |
| 165 mm, 6,75" | H0177.03 | H0151.01 | curved |
| 180 mm, 7,25" | H0149.01U | | curved |
| 180 mm, 7,25" | H0149U | | straight |
| 185 mm, 7,25" | H0083 | H0143 | straight |
| 185 mm, 7,25" | H0082 | H0143.01 | curved |
| 210 mm, 7,25" | H0276U | H0146.04U | straight |
| 210 mm, 7,25" | H0276.01U | H0146.05U | curved |
| 185 mm, 7,25" | | H0255 jaw 1,1mm | curved |
| 200 mm, 8" | H0150U | H0142 "Duck's nose" | straight |
| 200 mm, 8" | H0150.01U | H0142.01 "Duck's nose" | curved |
| 210 mm, 8,25" | | HR0714 | straight |
| 210 mm, 8,25" | | HR0715 | curved |
| 230 mm, 9,25" | | HR0716 | straight |
| 230 mm, 9,25" | | HR0717 | curved |
| 250 mm, 10" | | HR0720 | straight |
| 250 mm, 10" | | HR0750 | curved |
| 305 mm, 12" | | HR0718 | straight |
| 305 mm, 12" | | HR0719 | curved |

Codes are given for manufacturing without the lock,

Example: H0151.06

For manufacturing with lock add letter "L" to the code,

Example: H0151.06L

For manufacturing with "Universal" lock add letter "U" to the code,

Example: H0151.06U

H0142.01

Tungsten carbide plated jaws

TITANIUM

REGULAR NEEDLE HOLDERS

TITANIUM

Regular Vascular Needle Holders, Twisted

Round Handle Titanium

| Length\Tips | 0,8 mm | 1 mm | 1,2 mm | |
|---------------|-----------|------------|--------|----------|
| 165 mm, 6,75" | | HRS0710 | | straight |
| 180 mm, 7,25" | H0241.04L | | | straight |
| 185 mm, 7,25" | H0241.01U | HRS0712 | | straight |
| 185 mm, 7,25" | H0241U | HRS0713 | | curved |
| 200 mm, 8" | H0150M | | | straight |
| 200 mm, 8" | H0150M.01 | | | curved |
| 210 mm, 8,25" | | HRS0714 | | straight |
| 210 mm, 8,25" | | HRS0715 | | curved |
| 230 mm, 9,25" | H0291L | HRS0716 | | straight |
| 250 mm, 10" | | H0239L | H0292L | straight |
| 250 mm, 10" | | H0239.01L | | curved |
| 300 mm, 12" | | H0266 .01L | | curved |
| 305 mm, 12" | | HRS0718L | | straight |



Codes are given for manufacturing without the lock,

Example: H0151.06

For manufacturing with lock add letter "L" to the code, Example: H0151.06L

For manufacturing with "Universal" lock add letter "U" to the code, Example: H0151.06U

Tungsten carbide plated jaws

TITANIUM

Surgical Heavy Duty Needle Holders

Round Handle Titanium

| Length\Tips | 1,5 mm | 1,7 mm | 2 mm | |
|---------------|----------|---------|----------|----------|
| 165 mm, 6,75" | H0151.12 | | | straight |
| 165 mm, 6,75" | H0151.13 | | | curved |
| 210 mm, 7,25" | H0146.12 | HW0712 | H0226.02 | straight |
| 210 mm, 7,25" | H0146.13 | HW0713 | | curved |
| 210 mm, 8,25" | | HW0714 | | straight |
| 210 mm, 8,25" | | HW0715 | | curved |
| 230 mm, 9,25" | | HW0716 | | straight |
| 230 mm, 9,25" | | HW0717 | | curved |
| 250 mm, 10" | | HW0720 | | straight |
| 250 mm, 10" | | HW0750 | | curved |
| 305 mm, 12" | | HW0718 | | straight |
| 305 mm, 12" | | HWL0719 | | curved |

Surgical Heavy Duty Needle Holders

Round Handle Titanium

| Length\Tips | 2 mm | |
|---------------|----------|----------|
| 185 mm, 7,25" | H0268.01 | straight |
| 200 mm, 8" | H0267.01 | straight |

Codes are given for manufacturing without the lock,

Example: H0151.06

For manufacturing with lock add letter "L" to the code, Example: H0151.06L

For manufacturing with "Universal" lock add letter "U" to the code, Example: H0151.06U

Tungsten carbide plated jaws

TITANIUM

Double-Action Needle Holders

Round Handle with holes Titanium



| Length \ Tips | 0,8 mm | |
|---------------|-----------|----------|
| 155 mm, 6" | H0085 | straight |
| 155 mm, 6" | H0085.01 | curved |

Double-Action Needle Holders

Round Handle Titanium

| Length \ Tips | 0,8 mm | |
|---------------|-----------|----------|
| 170 mm, 7" | H0132.02 | straight |
| 170 mm, 7" | H0132.03 | curved |

Manufactured without lock

H0132.02
H0132.03

H0085
H0085.01

Tungsten carbide plated jaws

TITANIUM

NEEDLE HOLDERS

TITANIUM

Dauble-Action Needle Holders

Round Handle Titanium

| Length\Tips | 0.6 mm | |
|---------------|--------|----------|
| 185 mm, 7,25" | HD6001 | straight |
| 185 mm, 7,25" | HD6002 | curved |
| 210 mm, 8,25 | HD6003 | straight |
| 210 mm, 8,25 | HD6004 | curved |
| 230 mm, 9,25" | HD6011 | straight |
| 230 mm, 9,25" | HD6012 | curved |
| 250 mm, 10" | HD6021 | straight |
| 250 mm, 10" | HD6022 | curved |

| Length\Tips | 1 mm | |
|---------------|--------|----------|
| 165 mm, 6,75" | HR6007 | straight |
| 185 mm, 7,25" | HR6001 | straight |
| 185 mm, 7,25" | HR6002 | curved |
| 210 mm, 8,25 | HR6003 | straight |
| 210 mm, 8,25 | HR6004 | curved |
| 230 mm, 9,25" | HR6011 | straight |
| 230 mm, 9,25" | HR6012 | curved |
| 250 mm, 10" | HR6021 | straight |
| 250 mm, 10" | HR6022 | curved |
| 305 mm, 12" | HR6041 | straight |
| 305 mm, 12" | HR6042 | curved |

| Length\Tips | 1,7 mm | |
|---------------|-----------|----------|
| 210 mm, 8,25" | H0283.01L | straight |
| 210 mm, 8,25" | H0283L | curved |
| 250 mm, 10" | NW6021L | straight |

Codes are given for manufacturing without the lock,

Example: H0151.06

For manufacturing with lock add letter "L" to the code,

Example: H0151.06L

For manufacturing with "Universal" lock add letter "U" to the code,

Example: H0151.06U

Tungsten carbide plated jaws

TITANIUM



Bayonet Needle Holders, Delicate

Flat Handle Titanium

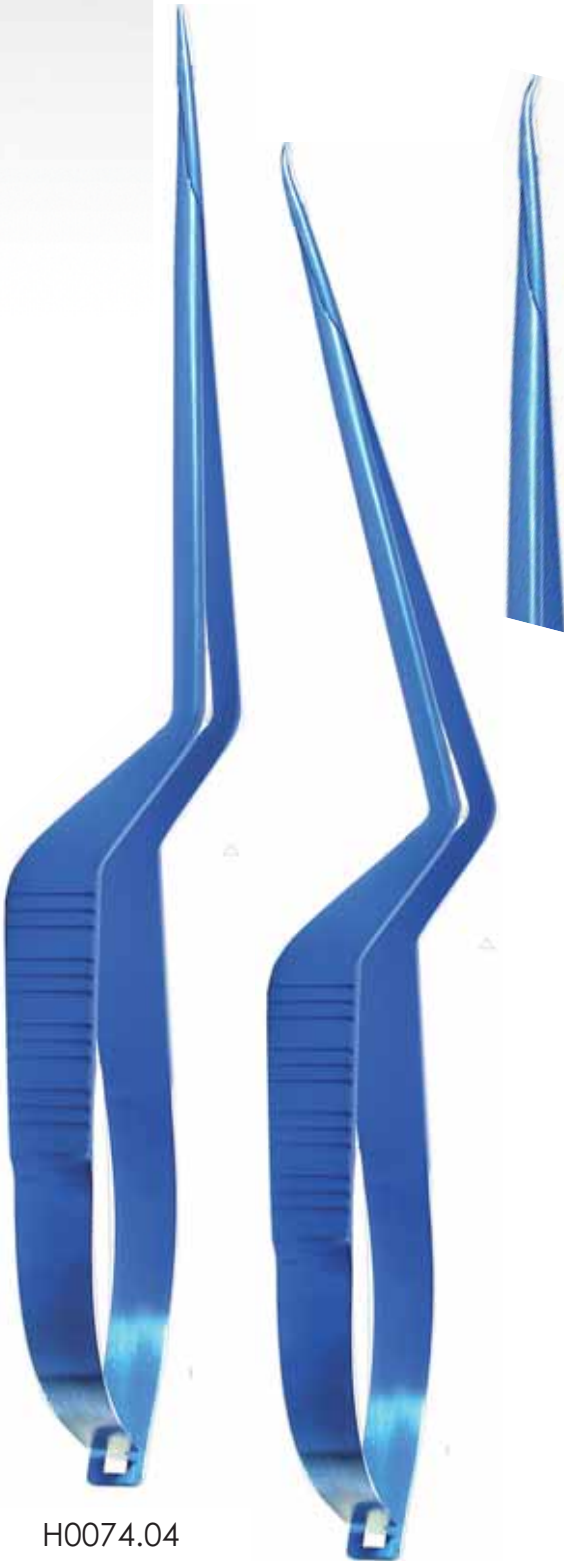

| Length\Tips | 0,6 mm | |
|-------------|-----------|----------|
| 200 mm, 8" | H0074.04 | straight |
| 200 mm, 8" | H0074.05 | curved |

Manufactured without lock

Bayonet Needle Holders, Delicate with lock

Flat Handle Titanium

| Length\Tips | 0,6 mm | |
|-------------|-----------|--------|
| 200 mm, 8" | H0075.01L | curved |

Manufactured with lock

H0074.04
H0074.05

H0075.01 L

Tungsten carbide plated jaws

TITANIUM

NEEDLE HOLDERS

TITANIUM

Bayonet Needle Holders, Regular "Duck's nose"

Round Handle Titanium

| Length\Tips | 0,9 mm | |
|---------------|-----------|----------|
| 235 mm, 9,25" | HR3010 | straight |

Bayonet Needle Holders, Regular "Duck's nose"

Flat Handle Titanium

| Length\Tips | 0,9 mm | |
|---------------|-----------|----------|
| 235 mm, 9,25" | HR3210 | straight |
| 235 mm, 9,25" | HR3212 | curved |



HR3210
HR3212

Tungsten carbide plated jaws

TITANIUM

Bayonet Needle Holders, Delicate

Flat Handle with holes Titanium

| Length\Tips | 0,6 mm | |
|---------------|----------|----------|
| 200 mm, 8" | H0074.06 | straight |
| 200 mm, 8" | H0074.07 | curved |
| 245 mm, 9,75" | H0238 | curved |

Manufactured without lock

Bayonet Needle Holders, Delicate with lock

Flat Handle with holes Titanium

| Length\Tips | 0,6 mm | |
|---------------|--------|--------|
| 245 mm, 9,75" | H0271L | curved |

Manufactured with lock

Bayonet Needle Holders, Delicate

Flat Handle with holes Titanium

| Length\Tips | 0,5 mm | |
|-------------|--------|--------|
| 200 mm, 8" | H0278 | curved |

Manufactured without lock



H0074.06
H0074.07
H0238
H0271L

H0278

Tungsten carbide plated jaws

TITANIUM

MICRO SCISSORS

Lancet-shaped Micro Scissors

Round Handle Titanium

| Length\Tips | Sharp/Fine Lancet-shaped | |
|-------------|--------------------------|----------|
| 150 mm, 6" | S0060 | straight |



S0060

Flat Handle Titanium

| Length\Tips | Sharp/Fine Lancet-shaped | |
|--------------|--------------------------|----------|
| 160 mm, 6,5" | S0063 | straight |



S0063



Round Handle - Titanium. Blades - Stainless Steel

| Length\Tips | Sharp/Fine Lancet-shaped | |
|-------------|--------------------------|----------|
| 180 mm, 7" | S0131 | straight |
| 180 mm, 7" | S0131.03 | curved |



S0131



Stainless Steel

STAINLESS
STEEL

UNIVERSAL SCISSORS

Universal Scissors (curved)

Round Handle Stainless Steel



S0059

| | | |
|-------------|-------------------------------|--------|
| Length\Tips | Sharp/Fine 13 mm blades | |
| 150 mm, 6" | S0059 | curved |



S0059.01

| | | |
|-------------|--------------------------|--------|
| Length\Tips | Blunt 13 mm blades | |
| 150 mm, 6" | S0059.01 | curved |

| | | |
|-------------|--------------------------|--------|
| Length\Tips | Blunt 17 mm blades | |
| 180 mm, 7" | S0225 | curved |
| 200 mm, 8" | S0144 | curved |



S0225
S0144.01

Universal Scissors (straight)

Round Handle Stainless Steel

| | | |
|-------------|--------------------------|----------|
| Length\Tips | Blunt 17 mm blades | |
| 200 mm, 8" | S0144.01 | straight |

Stainless Steel

MICRO SCISSORS

Scissors with Titanium Handle

Round Handle - Titanium/Blades - Stainless Steel

| Length\Tips | Sharp/Fine 15 mm blades | |
|-------------|-------------------------------|----------|
| 180 mm, 7" | S0131.01 | straight |

| Length\Tips | Blunt 15 mm blades | |
|-------------|--------------------------|----------|
| 180 mm, 7" | S0131.02 | straight |
| 180 mm, 7" | S0131.04 | curved |



Scissors with Titanium Handle (bent along the rib)

Round Handle - Titanium/Blades - Stainless Steel

| Length\Tips | Sharp/Fine 15 mm blades | |
|-------------|-------------------------------|----------------------|
| 180 mm, 7" | S0131.05 | 65° Angled blades |

STAINLESS
STEEL

UNIVERSAL SCISSORS

Universal Scissors (curved)

Flat Handle Stainless Steel



S0160



S0061.02
S0088



S0061.01



S0084



S0061

| Length\Tips | Sharp/Fine 9 mm blades | |
|-------------|------------------------------|--------|
| 150 mm, 6" | S0160 | curved |

| Length\Tips | Sharp/Fine 12 mm blades | |
|---------------|-------------------------------|--------|
| 160 mm, 6,25" | S0061.02 | curved |
| 180 mm, 7" | S0088 | curved |

| Length\Tips | Blunt 12 mm blades | |
|---------------|--------------------------|--------|
| 160 mm, 6,25" | S0061.01 | curved |

Universal Micro Scissors, straight

Flat Handle Stainless Steel

| Length\Tips | Sharp/Fine 12 mm blades | |
|-------------|-------------------------------|----------|
| 200 mm, 8" | S0084 | straight |

| Length\Tips | Blunt 12 mm blades | |
|-------------|--------------------------|----------|
| 160 mm, 8" | S0061 | straight |

Stainless Steel

SPECIAL SCISSORS

STAINLESS
STEEL

Scissors with micro-serrated blades, sharp-pointed (straight)

Round Handle Stainless Steel

| Length\Tips | Sharp/ Fine 8 mm serrated | Sharp 12 mm serrated | |
|---------------|------------------------------------|----------------------------|----------|
| 150 mm, 6" | S0129 | | straight |
| 210 mm, 8,25" | | S0128 | straight |



S0128

Scissors with micro-serrated blades, sharp-pointed (curved)

Round Handle Stainless Steel

| Length\Tips | Sharp 12 mm serrated | |
|---------------|----------------------------|--------|
| 210 mm, 8,25" | S0128.01 | curved |



S0128.01

Scissors with micro-serrated blades, blunt-pointed (straight)

Flat Handle Stainless Steel

| Length\Tips | Blunt 13 mm serrated | Blunt 22 mm serrated | |
|---------------|----------------------------|----------------------------|----------|
| 160 mm, 6,25" | S0061.03 | | straight |
| 200 mm, 8" | | S0083 | straight |



S0083

Blunt-pointed scissors with groove for veins

Flat Handle Stainless Steel

| Length\Tips | 2.0 mm | |
|-------------|-----------|----------|
| 180 mm, 7" | S0089 | straight |



S0089



Stainless Steel

STAINLESS
STEEL

CORONARY SCISSORS

Coronary Scissors

Round Handle Stainless Steel



S0226.02

S0260

S0260.02

S0226.01

| Length\Tips | Sharp 6 mm blades | Angled blades |
|----------------|----------------------|------------------|
| 210 mm, 8,25" | S4735 | 25° |
| 230 mm, 9,25" | S4740 | |
| 250 mm, 10,25 | S4747 | |
| 200 mm, 8" | S0246 | 45° |
| 210 mm, 8,25" | S4736 | |
| 230 mm, 9,25" | S4741 | |
| 250 mm, 10,25 | S4745 | 60° |
| 200 mm, 8" | S0246.01 | |
| 210 mm, 8,25" | S4737 | |
| 230 mm, 9,25" | S4742 | 125° |
| 250 mm, 10,25 | S4746 | |
| 165 mm, 6,25" | S0245 | |
| 200 mm, 8" | S0246.02 | 170° |
| 250 mm, 10,25" | S0242 | |
| 210 mm, 8,25" | S4738.170 | |

| Length\Tips | Sharp 9 mm blades | Angled blades |
|---------------|----------------------|------------------|
| 200 mm, 8" | S0260 | 45° |
| 210 mm, 8,25" | SL0736.1 | |
| 200 mm, 8" | S0260.02 | 60° |
| 200 mm, 8" | S0260.01 | 125° |
| 210 mm, 8,25" | S4738 | |

| Length\Tips | Sharp 15 mm blades | Angled blades |
|-------------|--------------------------|------------------|
| 180 mm, 7" | S0226.02 | 25° |
| 200 mm, 8" | S0145.13 | |
| 180 mm, 7" | S0226 | 45° |
| 180 mm, 7" | S0226.03 | 90° |
| 200 mm, 8" | S0145.14 | |
| 180 mm, 7" | S0226.01 | 120° |
| 200 mm, 8" | S0222 | |

Stainless Steel

CORONARY SCISSORS

Coronary Scissors (V-Necke)

Round Handle Stainless Steel

| Length\Tips | Sharp 9 mm blades | Angled blades |
|-------------|-------------------|---------------|
| 200 mm, 8" | S0260.03 | 125° |

| Length\Tips | Sharp 6 mm blades | Angled blades |
|---------------|-------------------|---------------|
| 210 mm, 8.25" | S4739 | 125° |



Bead Tip Coronary Scissors

Round Handle Stainless Steel

| Length\Tips | Bead 9 mm blades | Angled blades |
|-------------|------------------|---------------|
| 200 mm, 8" | S0241 | 45° |

| Length\Tips | Bead 15 mm blades | Angled blades |
|-------------|-------------------|---------------|
| 200 mm, 8" | S0145 | 45° |
| 200 mm, 8" | S0145.01 | 60° |
| 200 mm, 8" | S0145.02 | 120° |

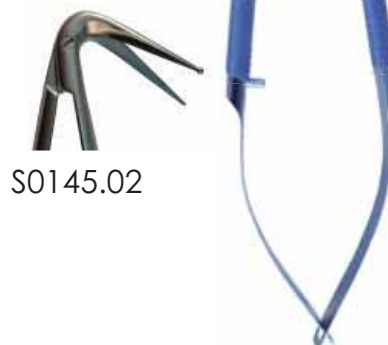

Stainless Steel

CORONARY SCISSORS

Coronary Scissors

Flat Handle Stainless Steel

| Length\Tips | Sharp 6 mm blades | Angled blades |
|-------------|----------------------|------------------|
| 200 mm, 8" | S4772 | 25° |
| 200 mm, 8" | S4774 | 45° |
| 200 mm, 8" | S4776 | 90° |
| 200 mm, 8" | S4777 | 125° |

| Length\Tips | Sharp 9 mm blades | Angled blades |
|---------------|----------------------|------------------|
| 210 mm, 8,25" | S5810.15 | 15° |
| 185 mm, 7,25" | S5763 | 25° |
| 200 mm, 8" | S5772 | |
| 185 mm, 7,25" | S5764 | 45° |
| 200 mm, 8" | S5774 | |
| 210 mm, 8,25" | S5814 | 60° |
| 200 mm, 8" | S5776 | 90° |
| 200 mm, 8" | S5777 | 125° |
| 210 mm, 8,25" | S5818 | 160° |
| 230 mm, 9,25" | S0263 | |
| 210 mm, 8,25" | S5818.170 | 170° |



Coronary Scissors «V-Neck»

Flat Handle Stainless Steel

| Length\Tips | Sharp 9 mm blades | Angled blades |
|---------------|----------------------|------------------|
| 200 mm, 8" | S5778 | 125° |
| 210 mm, 8,25" | S5820 | 125° |

| Length\Tips | Sharp 6 mm blades | Angled blades |
|-------------|----------------------|------------------|
| 200 mm, 8" | S4778 | 125° |

Stainless Steel

STAINLESS
STEEL

DOUBLE-ACTION SCISSORS

Double-Action Micro Scissors

Round Handle - Titanium/Blades - Stainless Steel

| Length\Tips | Sharp/Fine Lancet- shaped | Sharp 15 mm blades | |
|---------------|---------------------------------|--------------------------|----------------------|
| 155 mm, 6,25" | S0106.04 | S0106 | straight |
| 155 mm, 6,25" | | S0106.01 | curved |
| 155 mm, 6,25" | | S0106.05 | Angled blades 55° |

| Length\Tips | Blunt 15 mm blades | |
|---------------|--------------------------|----------|
| 155 mm, 6,25" | S0106.02 | straight |
| 155 mm, 6,25" | S0106.03 | curved |



S0106.04 S0106.01 S0106.02 S0106.05

Double-Action Scissors

Round Handle - Titanium/Blades - Stainless Steel

| Length\Tips | Sharp 10 mm blades | |
|---------------|--------------------------|----------|
| 170 mm, 6,25" | S0138.01 | straight |
| 170 mm, 6,25" | S0138 | curved |

Stainless Steel

DOUBLE-ACTION SCISSORS

STAINLESS
STEEL

Double-Action Scissors, left

Round Handle with Counter Balance - Titanium/ Blades - Stainless Steel

| Length\Tips | Sharp 8,5 mm blades | Left blades |
|---------------|---------------------------|----------------|
| 185 mm, 7,25" | S0148.02 | straight |
| 185 mm, 7,25" | S0148 | curved |

| Length\Tips | Sharp 13 mm blades | Left blades |
|---------------|--------------------------|----------------|
| 210 mm, 8,25" | S0148.03 | straight |
| 210 mm, 8,25" | S0148.01 | curved |

| Length\Tips | Sharp 18 mm blades | Right blades |
|-------------|--------------------------|----------------------|
| 305 mm, 12" | S6096 | Angled blades 60° |



S0148.01

Double-Action Scissors, Right

Round Handle with Counter Balance - Titanium/
Blades - Stainless Steel

| Length\Tips | Sharp 8,5 mm blades | Right blades |
|---------------|---------------------------|-----------------|
| 185 mm, 7,25" | S0147.02 | straight |
| 185 mm, 7,25" | S0147 | curved |

| Length\Tips | Sharp 13 mm blades | Right blades |
|---------------|--------------------------|-----------------|
| 210 mm, 8,25" | S0147.03 | straight |
| 210 mm, 8,25" | S0147.01 | curved |



S6096



Stainless Steel

STAINLESS
STEEL

BAYONET SCISSORS

Bayonet Scissors

Bayonet Flat Handle Stainless Steel



| Length\Tips | Sharp 15 mm blades | |
|---------------|-----------------------|----------|
| 200 mm, 8" | S0085.01 | straight |
| 200 mm, 8" | S0085 | curved |
| 230 mm, 9,25" | S0104 | straight |
| 230 mm, 9,25" | S0104.01 | curved |

| Length\Tips | Blunt 15 mm blades | |
|---------------|-----------------------|----------|
| 230 mm, 9,25" | S0104.02 | straight |
| 230 mm, 9,25" | S0104.03 | curved |



S0104.01



S0104.03

Stainless Steel

BAYONET SCISSORS

Bayonet Scissors

Bayonet Flat Handl Stainless Steel

| Length\Tips | Blunt 18 mm blades | |
|---------------|-----------------------|----------|
| 200 mm, 8" | S0086 | straight |
| 220 mm, 8,75" | S0086.01 | curved |
| 230 mm, 9,25" | S0086.02 | straight |

| Length\Tips | Bead 12 mm blades | Angled blades |
|-------------|----------------------|------------------|
| 200 mm, 8" | S0087 | 20° |

| Length\Tips | Sharp/Fine Lancet- shaped | |
|---------------|---------------------------------|----------|
| 235 mm, 9,25" | S3010.01 | straight |
| 235 mm, 9,25" | S3011.01 | curved |

| Length\Tips | Sharp 15 mm blades | |
|---------------|-----------------------|----------|
| 235 mm, 9,25" | S3010 | straight |
| 235 mm, 9,25" | S3011 | curved |



S0086



S0087



S3010.01



S3011



Stainless Steel

STAINLESS
STEEL

BAYONET SCISSORS

Bayonet Scissors

Bayonet Flat Handle with holes Stainless Steel



| Length\Tips | Sharp/Fine Lancet-shaped | |
|--------------|-----------------------------|----------|
| 215 mm, 8,5" | S0224.01 | straight |

| Length\Tips | Sharp/Fine 12 mm blades | |
|---------------|----------------------------|----------|
| 230 mm, 9,25" | S0267 | straight |
| 230 mm, 9,25" | S0267.01 | curved |

| Length\Tips | Multi-Purpose 18 mm blades | |
|---------------|-------------------------------|--------|
| 220 mm, 8,75" | S0223.01 | curved |



S0224.01



S0267.01



S0223.01

Stainless Steel

BAYONET SCISSORS

STAINLESS
STEEL

Bayonet Scissors

Bayonet Flat Handle with holes Stainless Steel

| Length\Tips | Sharp/Fine 12 mm blades | |
|---------------|----------------------------|----------|
| 230 mm, 9,25" | S0270 | straight |
| 230 mm, 9,25" | S0270.01 | curved |

| Length\Tips | Sharp/Fine 16 mm blades | |
|-------------|----------------------------|----------|
| 200 mm, 8" | S0271.01 | straight |
| 200 mm, 8" | S0271 | curved |

| Length\Tips | 14 mm blades | |
|---------------|-----------------|----------|
| 200 mm, 8" | S0266 | straight |
| 200 mm, 8" | S0266.01 | curved |
| 220 mm, 8,75" | S0266.02 | straight |
| 220 mm, 8,75" | S0266.03 | curved |
| 230mm, 9,25" | S0266.04 | straight |
| 230mm, 9,25" | S0266.05 | curved |



S0270.01



S027



S0266.01

Stainless Steel

STAINLESS
STEEL

CLAMPS

Vascular Clip

Stainless Steel

| Code № | Length | |
|-----------|--------|--------|
| ZT0009 | 16 mm | Small |
| ZT0009.01 | 18 mm | Medium |
| ZT0009.02 | 20 mm | Large |

Approximator

Stainless Steel

| Code № | Length | |
|----------|--------|--------|
| Z0110.00 | 16 mm | Small |
| Z0110.01 | 18 mm | Medium |
| Z0110.02 | 20 mm | Large |

Clip applicator

Titanium

| Length\Tips | 3,5 |
|-------------|-------|
| Z0110.00 | Z0015 |



ZT0009

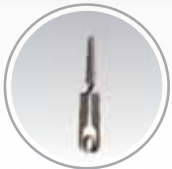

ZT0009.01



ZT0009.02



Z0110.02

CLAMPS

TITANIUM

Mini-Clamps with serration

Titanium

| Length\Tip | 1 mm | Serration | |
|-------------|----------|-----------|----------|
| 35 mm, 1,4" | Z0016 | Sharp | Straight |
| 35 mm, 1,4" | Z0016.01 | | Curved |
| 40 mm, 1,5" | Z0041 | Blunt | Straight |
| 40 mm, 1,5" | Z0041.01 | | Curved |



Z0041

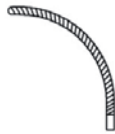

Z0041.1



Z0016



Z0016.01



Z0016.01

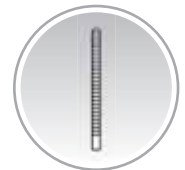
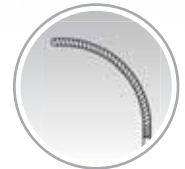
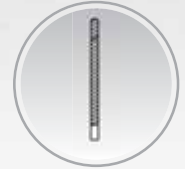

Bulldog Clamps with serration, straight

Titanium

| Length\Tip | 1x10 mm | 1x15 mm | 1x20 mm |
|--------------|---------|----------|----------|
| 45 mm, 1,75" | Z0088 | | |
| 50 mm, 1,75" | | Z0088.01 | |
| 55 mm, 2" | | | Z0088.02 |

Z0088



Bulldog Clamps with serration angled 60°

Titanium

| Length\Tip | 1x10 mm | 1x15 mm | 1x20 mm | 2x8 mm |
|--------------|---------|----------|----------|----------|
| 45 mm, 1,75" | Z0087 | | | Z0009.05 |
| 47 mm, 2" | | Z0087.01 | | |
| 50 mm, 2,25" | | | Z0087.02 | |

Z0087



TITANIUM

TITANIUM

CLAMPS ATRAUMA

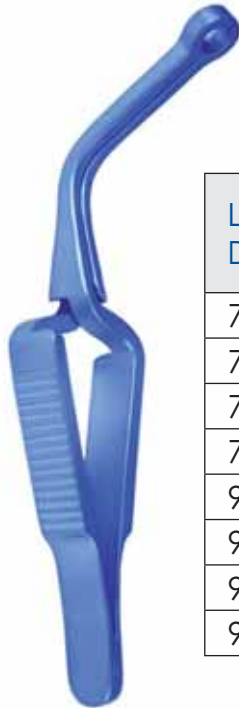

Z2214

Ring tip Clamps

Titanium

| Length\ Diameter | Ø3,3x Ø6,3 mm | Ø4,0x Ø7,0 mm | Ø4,7x Ø7,7 mm | Angled |
|---------------------|---------------------|---------------------|---------------------|--------|
| 75 mm, 3" | Z2202 | | | 10° |
| 75 mm, 3" | Z2204 | | | 25° |
| 75 mm, 3" | Z2206 | | | 45° |
| 75 mm, 3" | Z2208 | | | 60° |
| 95 mm, 3,75" | | Z2210 | Z228 | 10° |
| 95 mm, 3,75" | | Z2212 | Z2220 | 25° |
| 95 mm, 3,75" | | Z2214 | Z2222 | 45° |
| 95 mm, 3,75" | | Z2216 | Z2224 | 60° |

De Bakey Bulldog Clamps, Atrauma

Titanium



Z0035.03

| Width\ Length | 2,5 mm | |
|------------------|-----------|------------|
| 55 mm, 2,25" | Z0035.02 | Angled 90° |
| 62 mm, 2,5" | Z0035.03 | Angled 45° |
| 60 mm, 2,5" | Z0035.01 | Curved |
| 60 mm, 2,5" | Z0035 | Straight |
| 105 mm, 4,25" | Z0035.04 | Angled 90° |

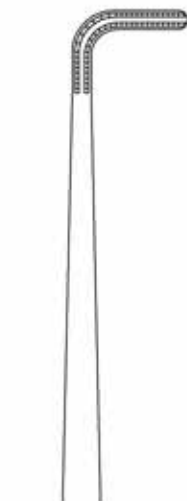

Z0035.04



Z0035



Z0035.01



Z0035.03



Z0035.02

TITANIUM

CLAMPS ATRAUMA

TITANIUM

De Bakey Bulldog Clamps, curved

Titanium

| Length\Width | 2,9 mm |
|---------------|----------|
| 75 mm, 3" | Z0033.04 |
| 80 mm, 3,25" | Z0033.05 |
| 95 mm, 4" | Z0033.06 |
| 105 mm, 4,25" | Z0033.07 |

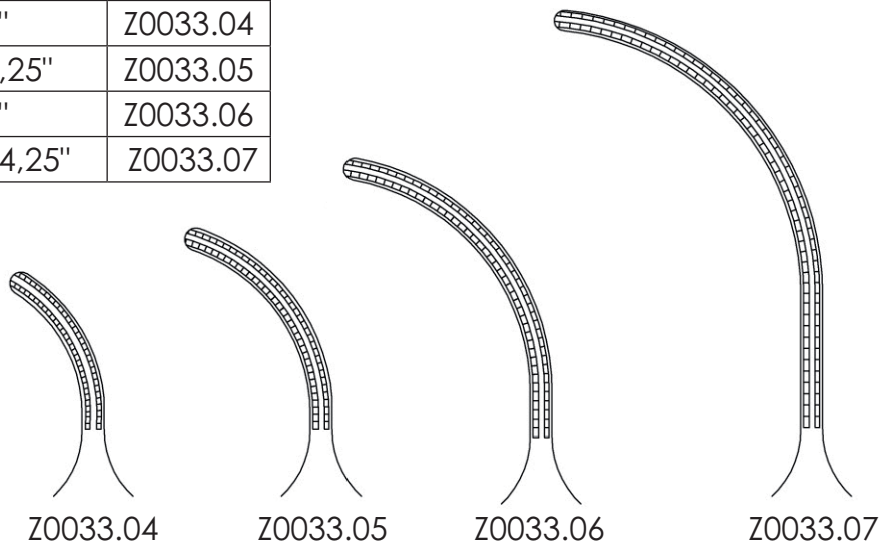

De Bakey Bulldog Clamps, straight

Titanium

| Length\Width | 2,9 mm |
|---------------|----------|
| 80 mm, 3,25" | Z0033 |
| 90 mm, 3,75" | Z0033.01 |
| 105 mm, 4,25" | Z0033.02 |
| 125 mm, 5" | Z0033.03 |

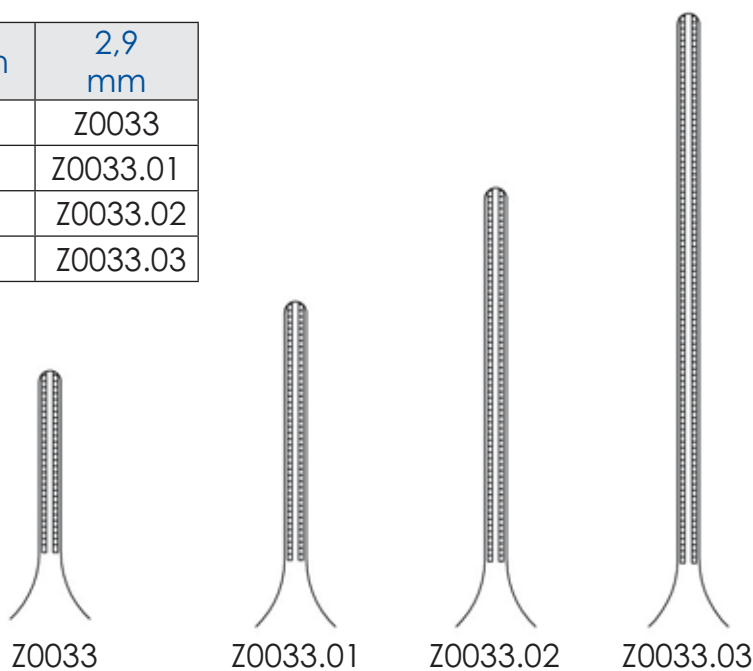

TITANIUM

Vascular Dilators (Probes)

Stainless Steel

| Code № | Length | Shaft |
|-----------|--------|--------|
| PD0045 | 180 mm | 1,0 mm |
| PD0045.01 | | 1,5 mm |

| Code № | Length | Olive |
|-----------|------------|--------|
| PD0045.02 | 180 mm, 7" | 2 mm |
| PD0045.03 | | 2,5 mm |
| PD0045.04 | | 3 mm |
| PD0045.05 | | 3,5 mm |
| PD0045.06 | | 4 mm |
| PD0045.07 | | 4,5 mm |
| PD0045.08 | | 5 mm |



Stainless Steel

Vascular Dilators (Probes)

Stainless Steel

| Code № | Length | Shaft |
|-----------|-------------|-------|
| PD0105.04 | 280 mm, 11" | 2 mm |
| PD0105.03 | | 4 mm |
| PD0105.02 | | 6 mm |
| PD0105.01 | | 8 mm |
| PD0105 | | 10 mm |

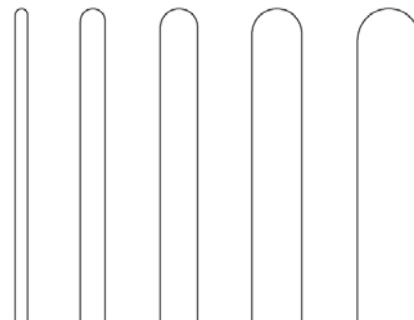

Vascular Dilators (Probes)

Stainless Steel

| Code № | Length | Olive |
|-----------|---------------|-------|
| PD0104 | 200 mm, 8,25" | 3 mm |
| PD0104.01 | | 4 mm |
| PD0104.02 | | 5 mm |
| PD0104.03 | | 6 mm |
| PD0104.04 | | 7 mm |
| PD0104.05 | | 8 mm |
| PD0104.06 | | 9 mm |
| PD0104.07 | | 10 mm |
| PD0104.08 | | 11 mm |
| PD0104.09 | | 12 mm |

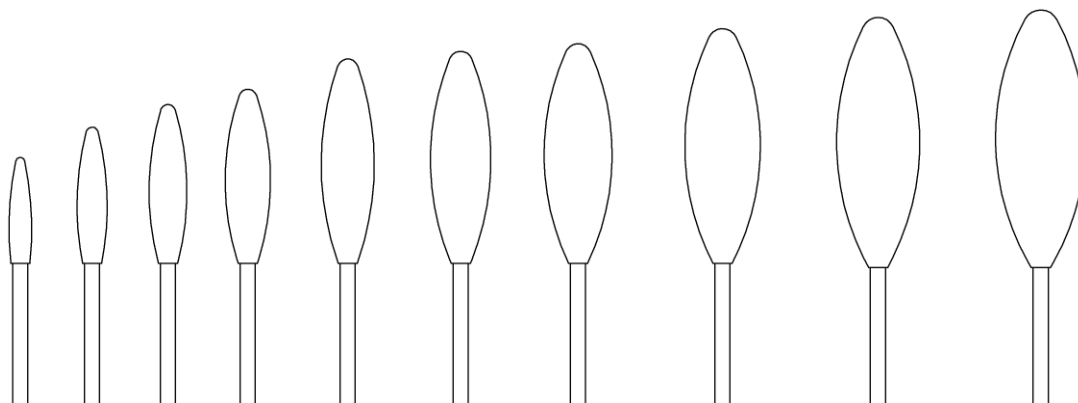

Stainless Steel

STAINLESS
STEEL

VASCULAR DILATORS

Vascular Dilators (Probes)

Stainless Steel

| No | length | olive |
|-----------|----------------|-------|
| PD0104.10 | 320 mm, 12,75" | 13 mm |
| PD0104.11 | | 14 mm |
| PD0104.12 | | 15 mm |
| PD0104.13 | | 16 mm |
| PD0104.14 | | 17 mm |
| PD0104.15 | | 18 mm |
| PD0104.16 | | 19 mm |
| PD0104.17 | | 20 mm |
| PD0104.18 | | 21 mm |
| PD0104.19 | | 22 mm |

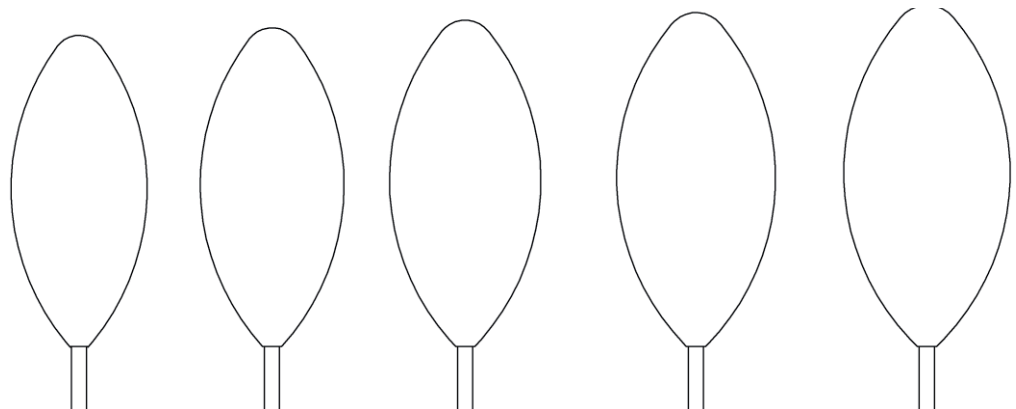
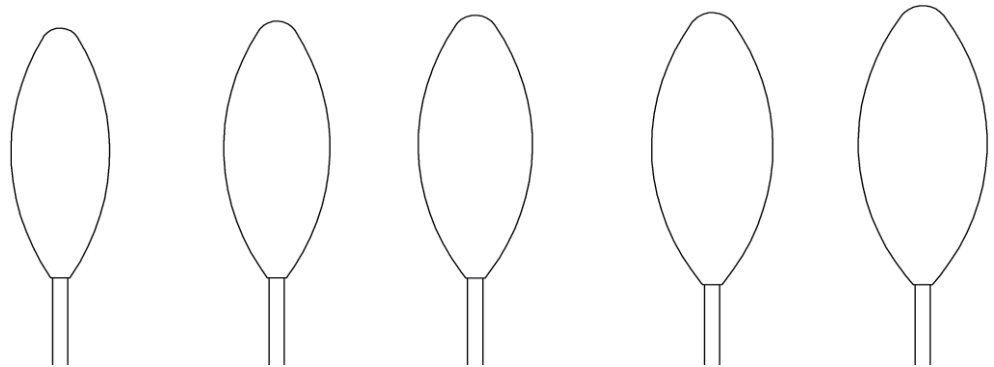

Stainless Steel

DISSECTORS

Vascular Dissectors

Handle - Titanium/Shaft - Stainless Steel

| Tip\Length | 2 mm | 3 mm | 4,7 mm | 5 mm | |
|---------------|----------|-------|--------|----------|-------|
| 220 mm, 8,6" | D0027.01 | D0027 | | D0027.02 | Sharp |
| 220 mm, 8,6" | | | | D0043 | |
| 170 mm, 6,75" | | | D0041 | | |



D0027



D0041



D0043

Bayonet Vascular Dissectors

Handle - Titanium/Shaft - Stainless Steel

| Tip\Length | 2 mm | 2,5 mm | 3 mm | 4,5 mm |
|---------------|-------|--------|-------|--------|
| 220 mm, 8,6" | D0028 | | D0040 | |
| 220 mm, 8,6" | | | | D0042 |
| 230 mm, 9,25" | | D0022 | | |



Stainless Steel-TITANIUM

STAINLESS
STEEL
TITANIUM

DISSECTORS

Vascular Loop

Handle - Titanium/Shaft - Stainless Steel

| | |
|-------------|---------------|
| Lenght\Ring | 4,5x2,5 mm |
| 200 mm, 8" | L0011 |

Bayonet Vascular Loop

Handle - Titanium/Shaft - Stainless Steel

| | |
|-------------|-------------|
| Lenght\Ring | 8x5,0 mm |
| 200 mm, 8" | L0012 |



L0011

L0012

Stainless Steel-TITANIUM

DISSECTORS

STAINLESS
STEEL
TITANIUM

Neuro-Surgery Dissectors

Titanium

| Length\Ball tip | Ø 0,9 mm | | |
|-----------------|----------|-------|------------|
| 190 mm, 7,5" | D9114 | Small | Angled 90° |
| 190 mm, 7,5" | D9115 | Large | Angled 90° |
| 190 mm, 7,5" | D9116 | | straight |
| 190 mm, 7,5" | D9117 | Small | Angled 45° |
| 190 mm, 7,5" | D9118 | Large | Angled 45° |



D9114 D9115 D9116 D9117 D9118

Neuro-Surgery Spatula - Dissectors

Titanium

| Length\Tip | 1,4 mm | 1,6 mm | 2,4 mm |
|--------------|--------|--------|--------|
| 190 mm, 7,5" | D9105 | D9106 | D9107 |



Stainless Steel-TITANIUM

Neuro-Surgery Elevators

Titanium



| Length\Tip | 1,25 mm | 1,4 mm |
|--------------|---------|--------|
| 190 mm, 7,5" | DL9103 | DL9103 |



| Length\Ball tip | 1.0 mm | 2.0 mm | 3.0 mm |
|-----------------|--------|--------|--------|
| 190 mm, 7,5" | DL9100 | DL9101 | DL9102 |

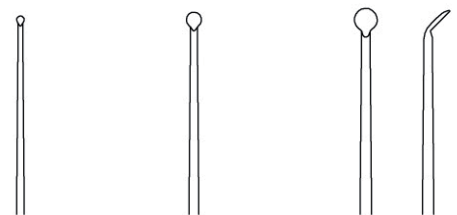

TITANIUM

DISSECTORS

Bayonet Neuro-Surgery Dissectors

Titanium

| Length\Tip | 2 mm | Curved | |
|--------------|--------|--------|-------|
| 240 mm, 9,4" | DL9009 | Up | Blunt |
| 240 mm, 9,4" | DL9010 | Down | |

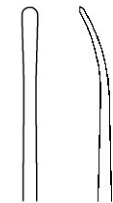

DL9009

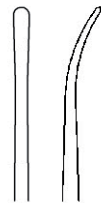

DL9010

Bayonet Neuro-Surgery Elevators

Titanium

| Length\Ball tip | 3 mm | Angled |
|-----------------|--------|--------|
| 240 mm, 9,4" | DL9050 | 45° |

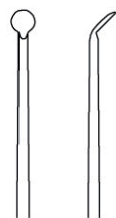

STAINLESS
STEEL
TITANIUM

HOOKS

Mitral Valve Hooks

Round Handle - Titanium/Shaft - Stainless Steel

| Length\Ball tip | 1 mm | 1,5 mm | 2 mm | |
|-----------------|----------|----------|----------|------------|
| 220 mm, 8,75" | E0038.07 | E0038.06 | | Straight |
| 220 mm, 8,75" | | E0038.02 | E0038.04 | Angled 90° |
| 220 mm, 8,75" | | E0038.03 | E0038.05 | Angled 90° |

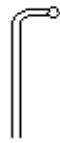

E0038.02



E0038.03



E0038.04

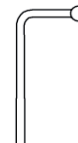

E0038.05



E0038.07



E0038.06

| Length\Tip | 1 mm | Angled |
|---------------|----------|--------|
| 220 mm, 8,75" | E0038 | 90 ° |
| 220 mm, 8,75" | E0038.01 | 90 ° |



E0038



E0038.01

Hook with serration

Round Handle - Titanium/Shaft - Stainless Steel



E0086

| Length\Tip | 1,5 mm | Angled |
|---------------|--------|--------|
| 235 mm, 9,25" | E0086 | 90 ° |

Stainless Steel-TITANIUM

HOOKS

Fine Wound and Nerve Hooks

Titanium

| Length\Tip | 0,2 mm | 0,3 mm | 0,5 mm | Angled |
|--------------|--------|--------|--------|--------|
| 190 mm, 7,5" | DL9108 | DL9109 | DL9130 | 90° |
| 190 mm, 7,5" | | DL9110 | | 45° |



E9108



E9109



E9110



E9130

Fine Wound – and Nerve Hooks

Handle - Titanium/Shaft - Stainless Steel

| Length\Tip | 0,4 mm | 0,6 mm |
|---------------|----------|--------|
| 185 mm, 7,25" | E0062.01 | E0062 |



E0062.01



E0062



E9108

E0062.01

Stainless Steel-TITANIUM

STAINLESS
STEEL
TITANIUM

HOOKS

Fine Wound and Nerve Hooks

Handle - Titanium/Shaft - Stainless Steel

| Length\Ball tip | ø 0,4 mm | ø 0,5 mm | ø 0,7 mm | Angled |
|-----------------|----------|----------|----------|--------|
| 180 mm, 7" | MH0017 | | | 30 ° |
| 180 mm, 7" | MH0015 | | MH0016 | 45 ° |
| 180 mm, 7" | | MH0018 | | 90° |



MH0015



MH0016



MH0017

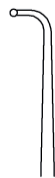

MH0018

Round Handle - Titanium/Shaft - Stainless Steel

| Length\Ball tip | ø 0,4 mm | ø 0,5 mm | ø 0,7 mm | Angled |
|-----------------|----------|----------|----------|--------|
| 180 mm, 7" | | MH0019 | | 90 ° |
| 220 mm, 8,25" | E0063 | | | 45 ° |
| 220 mm, 8,25" | | | E0063.01 | 35° |



E0063



MH0019



E0063.01

Stainless Steel-TITANIUM

HOOKS

STAINLESS
STEEL
TITANIUM

Hook with Configured jaw

Round Handle - Titanium/Shaft - Stainless Steel

| Length\Tip | 0,3 mm |
|------------|--------|
| 180 mm, 7" | MH0021 |



MH0021

Hook with Cutting edge

Round Handle - Titanium/Shaft - Stainless Steel

| Length\Tip | Sharp 1,5mm blade | Sharp 2 mm blade |
|---------------|-------------------|------------------|
| 180 mm, 7" | MH0020 | |
| 185 mm, 7,25" | | E1190 |



MH0020

E1190

Hooks for fallopian tubes

Round Handle - Titanium/Shaft - Stainless Steel

| Length\Tip | 1,0 mm | 1,5 mm ball | 2,5 mm ball |
|----------------|--------|-------------|-------------|
| 210 mm , 8,25" | MH0022 | MH0022.01 | MH0022.02 |



MH0020

MH0022

Stainless Steel-TITANIUM

STAINLESS
STEEL
TITANIUM

HOOKS

In Situ Bypass Hooks

Round Handle - Titanium/Shaft - Stainless Steel



| Length\Tip | 0,3 mm | 0,4 mm | Angled |
|------------|--------|----------|-----------------|
| 230 mm, 9" | E0064 | E0064.01 | 90 ° down wards |



E0064



E0064.01

| Length\Tip | 0,5 mm | 1,0 mm | Angled |
|------------|----------|----------|-----------------|
| 230 mm, 9" | E0064.02 | E0064.03 | 30 ° down wards |



E0064.02



E0064.03

| Length\Ball tip | 0,8 mm | 1,0 mm | |
|-----------------|--------|--------|----------------------|
| 230 mm, 9" | MH0025 | | Angled 90 ° up wards |
| 240 mm, 9,5" | | E0072 | Curved |



MH0025



E0072

Stainless Steel-TITANIUM

HOOKS

Styilet for pulling sutures Styilet for use with 6mm and 8mm huggers

Stainless Steel

| | |
|---------------|------------|
| Length\Tip | 1,1x0,5 mm |
| 210 mm, 8,25" | E0010 |



Double-Ended Hook-Spatula

Stainless Steel

| Length\Tip | 1,4 mm Hook 1,5 mm Spatula | 1,7 mm Hook 2 mm Spatula | Ø 1,2 mm Hook 2 mm Spatula |
|------------|-------------------------------|-----------------------------|-------------------------------|
| 180 mm, 7" | E1150 | E1152 | E1160 |



E1160



E1150
E1152



Stainless Steel

STAINLESS
STEEL
TITANIUM

HOOKS

Wound and Vein Retractors

Stainless Steel



E0059



E0059.02
E0059.03



E0059
E0059.01



E0059.04

| Code № | Length | Width |
|----------|------------------|-------|
| E0059.03 | 140 mm, 5,75" | 4 mm |
| E0059.02 | | 6 mm |
| E0059.01 | | 8 mm |
| E0059 | | 10 mm |
| E0059.04 | | 14 mm |
| E0059.05 | | 18 mm |
| E0059.06 | | 20 mm |
| E0059.07 | | 25 mm |



E0059.05



E0059.06



E0059.07

Soft Tissue Retractors

Round Handle - Titanium/Shaft - Stainless Steel



E0016

| Code № | Length | Width |
|--------|------------------|--------|
| E0016 | 200 mm, 8,25" | 3,5 mm |
| E1082 | | 5 mm |
| E0017 | | 8 mm |



E0016



E1082



E0017

Stainless Steel-TITANIUM

HOOKS

Soft Tissue Retractors

Round Handle - Titanium/Shaft - Stainless Steel

| Code № | Length | Width | |
|----------|---------------|-------|----------------|
| E0054 | 170 mm, 6,75" | 6 mm | |
| E0055.02 | | 6 mm | with serration |
| E0055.03 | | 6 mm | |

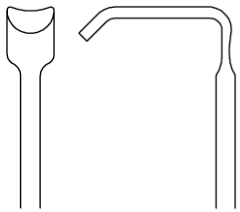

E0054

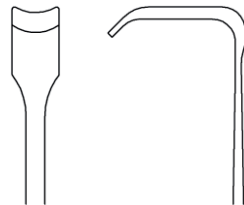

E0055.03

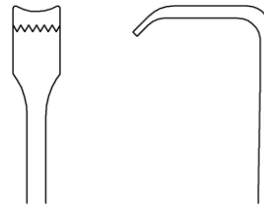

E0055.02



Soft Tissue Hooks 3 prongs

Round Handle - Titanium/Shaft - Stainless Steel

| Length\Tip | 8 mm | |
|--------------|-------|-------|
| 135 mm, 5,5" | E0047 | Blunt |

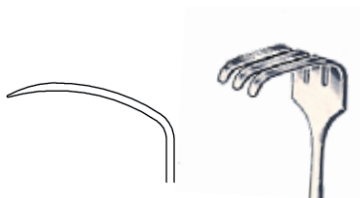

E0047

Stainless Steel-TITANIUM

STAINLESS
STEEL
TITANIUM

HOOKS

Wound and Trachea Retractors 2 prongs for fixation

Handle - Titanium/Shaft - Stainless Steel



| Length\Width | 2,1 mm | 2,6 mm | |
|---------------|-----------|-----------|-------|
| 120 mm, 4,75" | E0048 | | Sharp |
| 120 mm, 4,75" | | E0048.01 | |

Wound and Trachea Retractors 2 prongs

Handle - Titanium/Shaft - Stainless Steel



| Length\Width | 3 mm | 3,3 mm | |
|---------------|---------|-----------|-------|
| 180 mm, 7" | E0056 | | Sharp |
| 200 mm, 8,25" | | E0014 | |

Wound and Trachea Retractors 3 prongs

Handle - Titanium/Shaft - Stainless Steel



| Length\Width | 5 mm | |
|--------------|---------|-------|
| 180 mm, 7" | E0057 | Sharp |

Wound and Trachea Retractors 4 prongs

Handle - Titanium/Shaft - Stainless Steel



| Length\Width | 8 mm | |
|---------------|---------|-------|
| 200 mm, 8,25" | E0015 | Sharp |

Stainless Steel-TITANIUM

CURETTE

STAINLESS
STEEL
TITANIUM

Bayonet Curette

Handle - Titanium / Shaft - Stainless Steel

| Length \ Ring | 3,0 mm | 4,0 mm | 5,0 mm | |
|---------------|----------|----------|----------|--------------------|
| 240 mm, 9,5" | K0053 | | | Straight |
| 240 mm, 9,5" | K0053.01 | | | Angled 45° Left |
| 240 mm, 9,5" | | K0054 | K0054.02 | Angled 45° Right |
| 240 mm, 9,5" | | K0054.01 | K0054.03 | Angled 45° Left |
| 240 mm, 9,5" | | | K0055 | Angled 45° Upwards |

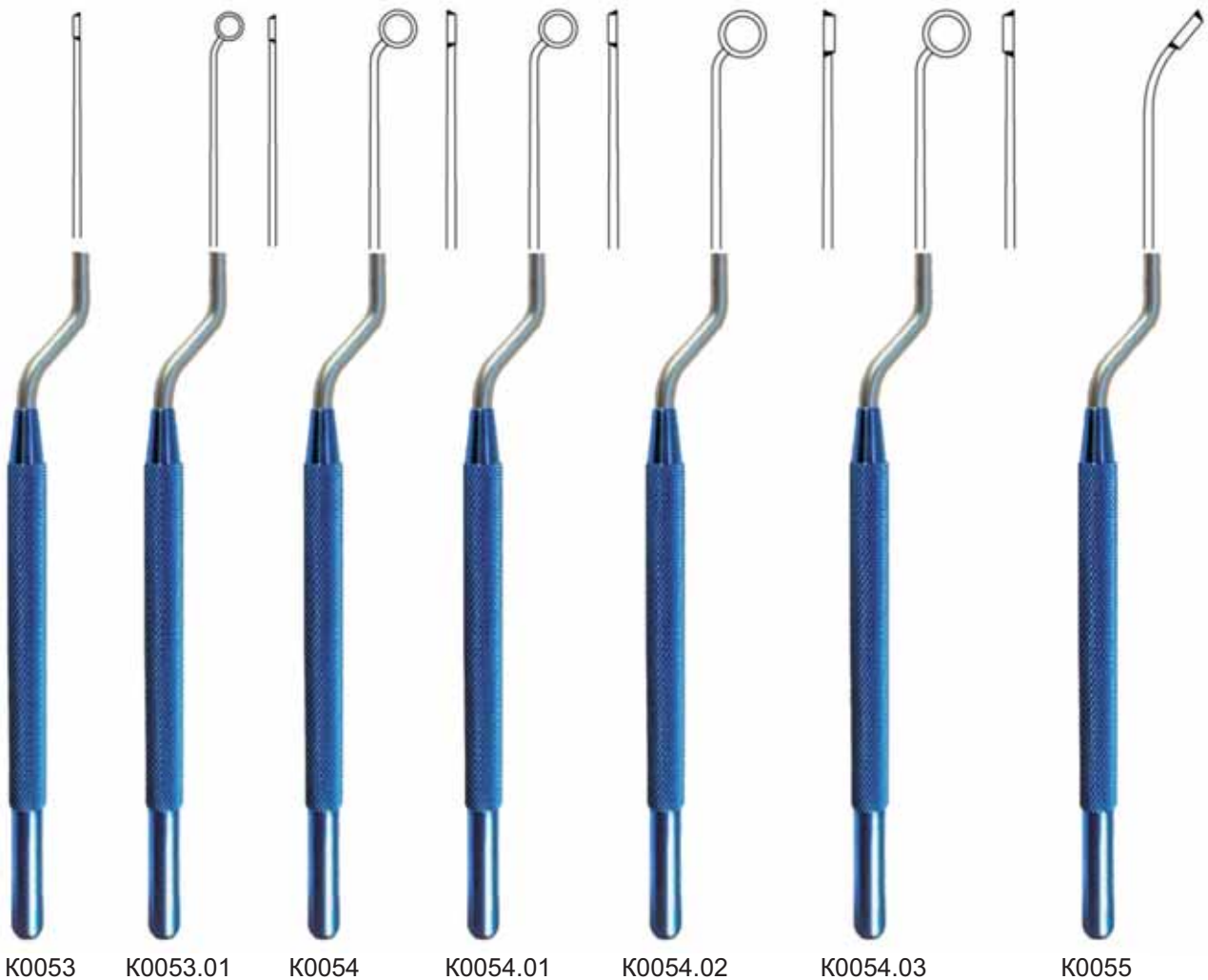

Stainless Steel-TITANIUM

STAINLESS
STEEL
TITANIUM

CURETTE

Bayonet Curette

Handle - Titanium/Shaft - Stainless Steel

| Length\ Ring | 2,5 mm | 3,0 mm | 3,5 mm | 4,0 mm | 4,5 mm | Angled |
|-------------------|-----------|-----------|-----------|-----------|-----------|----------------|
| 260 mm, 10,25" | K0043.05 | K0043.06 | K0043.07 | K0043.08 | K0043.09 | Upwards 90° |
| 260 mm, 10,25" | K0043 | K0043.01 | K0043.02 | K0043.03 | K0043.04 | |

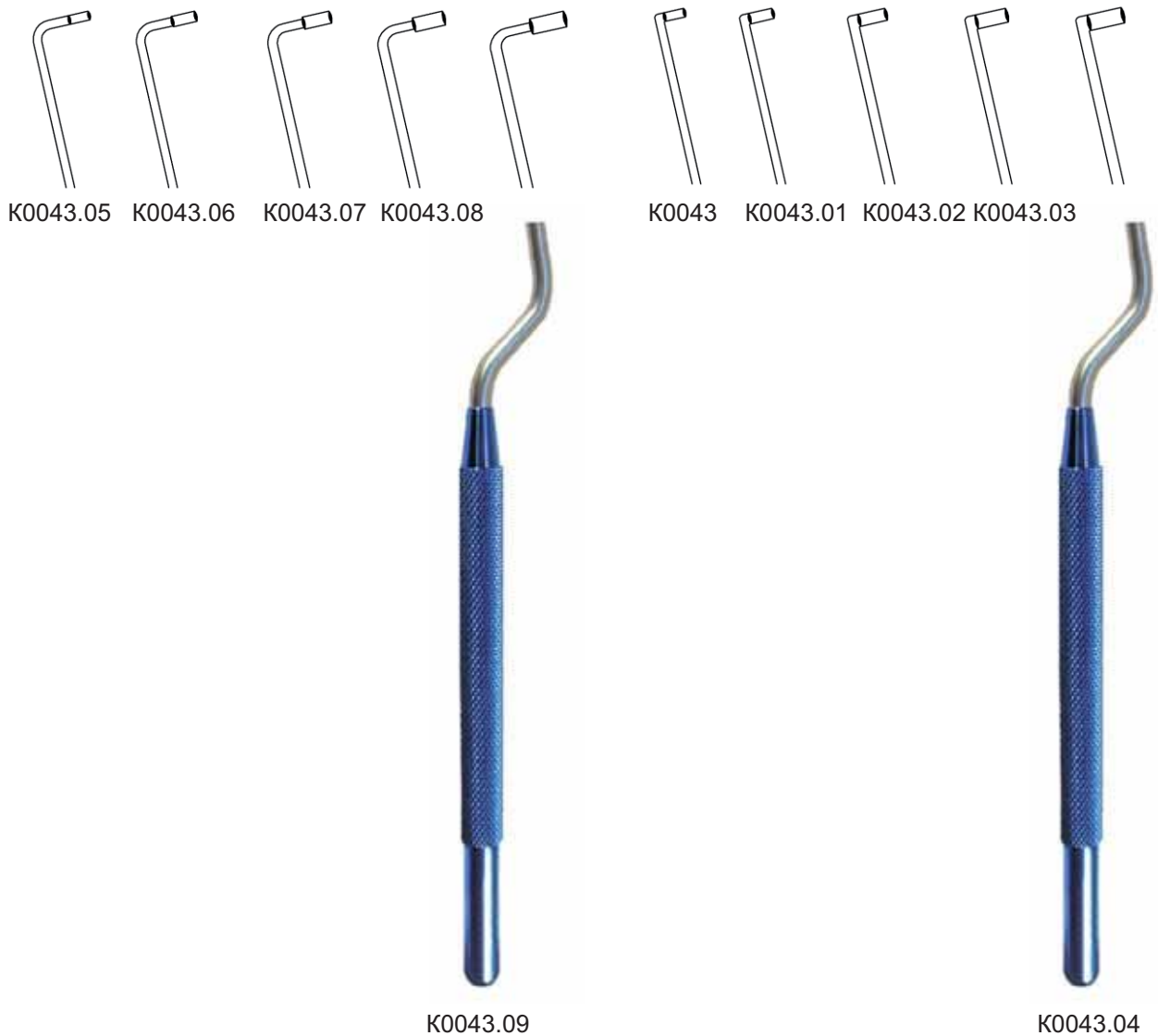

Stainless Steel-TITANIUM

CURETTE

STAINLESS
STEEL
TITANIUM

Bayonet Curette

Handle - Titanium / Shaft - Stainless Steel

| Length \ Ring | 2,5 mm | 3,0 mm | 3,5 mm | 4,0 mm | Angled |
|----------------|----------|----------|----------|----------|------------------------|
| 260 mm, 10,25" | K0088 | K0088.01 | K0088.02 | K0088.03 | Upwards 45° |
| 260 mm, 10,25" | K0088.04 | K0088.05 | K0088.06 | K0088.07 | Upwards 45°; Turned |

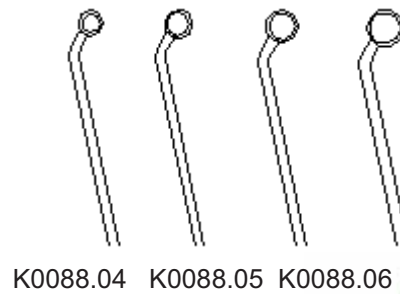
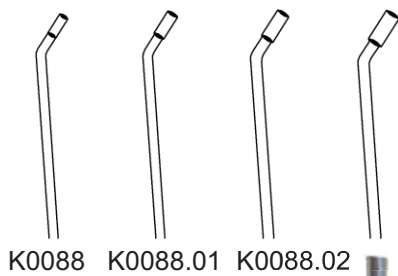

K0088.03



K0088.07

Stainless Steel-TITANIUM

TITANIUM

CURETTE

Bayonet Curette

Titanium

| Length\Ring | 3,0 mm | 5,0 mm | Angled |
|-------------|--------|--------|-----------|
| | K9001 | K9002 | Up 90° |
| | K9003 | K9004 | Down 90° |
| | K9007 | | Up 45° |
| | | K9008 | Down 45° |
| | K9005 | | Right 45° |
| | | K9006 | Left 45° |

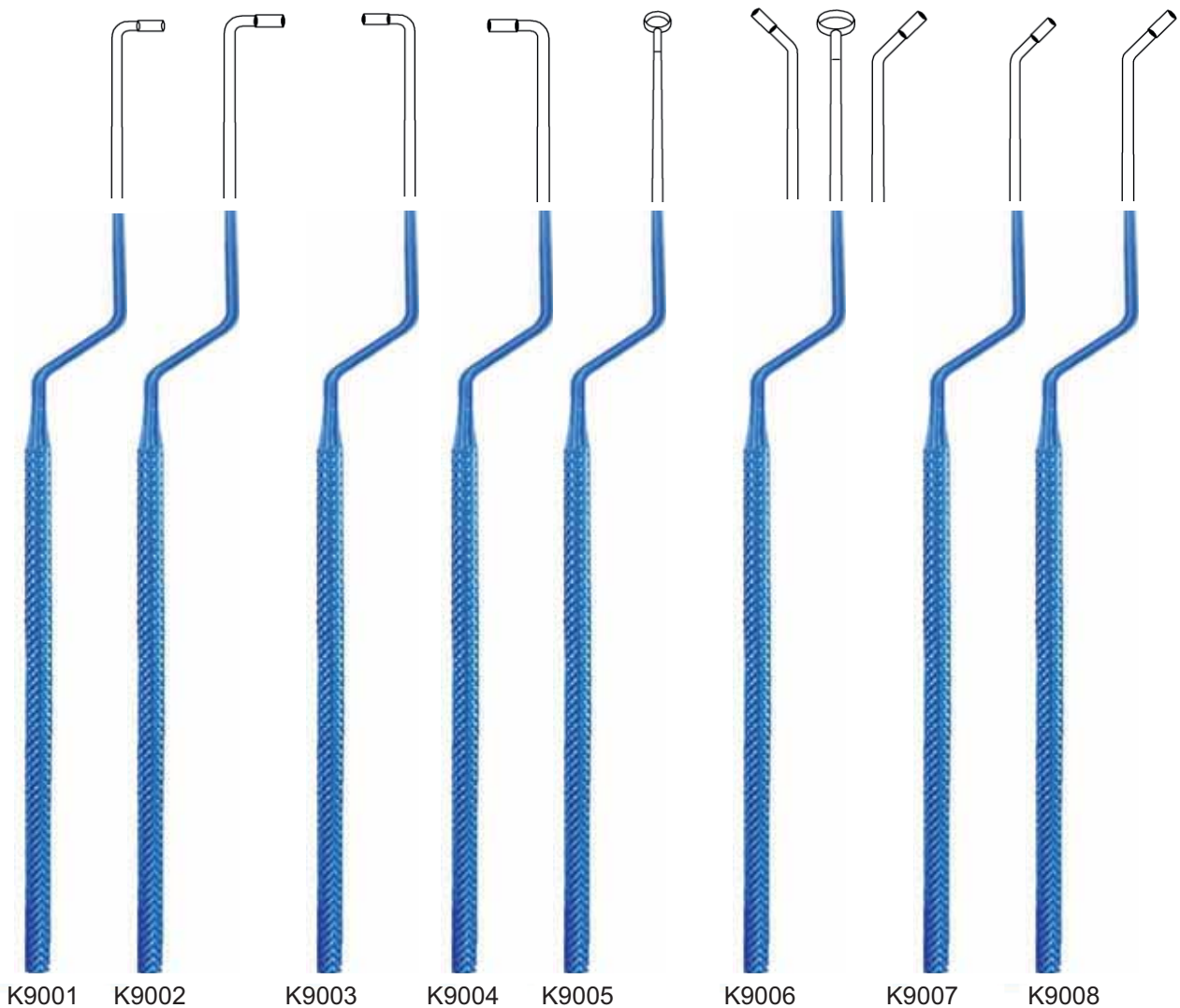

TITANIUM

CURETTE

Bayonet Curette

Titanium

| Length \ Ring | 2,2 mm | |
|---------------|--------|------------|
| 190 mm, 7,5" | K9112 | Straight |
| 190 mm, 7,5" | K9113 | Angled 45° |



K9112



K9113



STAINLESS
STEEL
TITANIUM

MISCELLANEOUS

Diamond Knife

Titanium

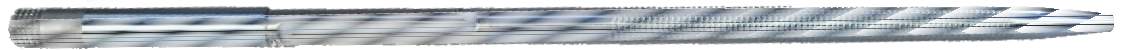
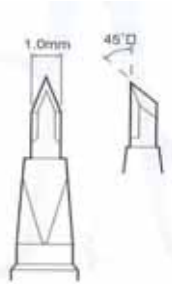

| Length | Code № |
|-------------|--------|
| 190 mm 7,5" | K0039 |

Blade Holder

Stainless Steel

| Length\Tip | 2,0 mm | |
|---------------|-----------|------------|
| 200 mm, 8,25" | B0002 | Straight |
| 200 mm, 8,25" | B0003 | Angled 45° |



Aorta/Vein Punch

Stainless Steel

| Length\Tip | 2,5 mm | 3,0 mm | 3,5 mm | 4,0 mm |
|---------------|-----------|-----------|-----------|-----------|
| 180 mm, 7,25" | K0062.00 | K0062.01 | K0062.02 | K0062.03 |
| 200 mm, 8,25" | K0062.04 | K0062.05 | K0062.06 | K0062.07 |
| 230 mm, 9,25" | K0062.08 | K0062.09 | K0062.10 | K0062.11 |

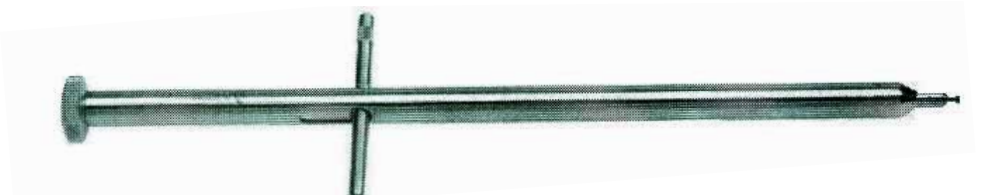

Stainless Steel-TITANIUM

MISCELLANEOUS

Retractors

Stainless Steel

| Code № | total length | |
|--------|--------------|--------|
| TL0080 | 25 mm | mini |
| TL0081 | 31 mm | small |
| TL0082 | 38 mm | medium |
| TL0083 | 54 mm | slarge |



Retractors for duodenum

Stainless Steel

| Code № | total length | blades |
|--------|--------------|--------|
| RE0005 | 80 mm | 25 |



RE0005

Retractors

Titanium

| Code № | total length | blades |
|--------|--------------|--------|
| RE0007 | 100 mm | 10 |



RE0007

Retractors

Titanium

| Code № | total length | blades |
|--------|--------------|--------|
| RE0006 | 80 mm | 7 |



RE0006

Stainless Steel-TITANIUM

STAINLESS
STEEL
TITANIUM

MISCELLANEOUS

Pediatric Ribs Retractor

Stainless Steel

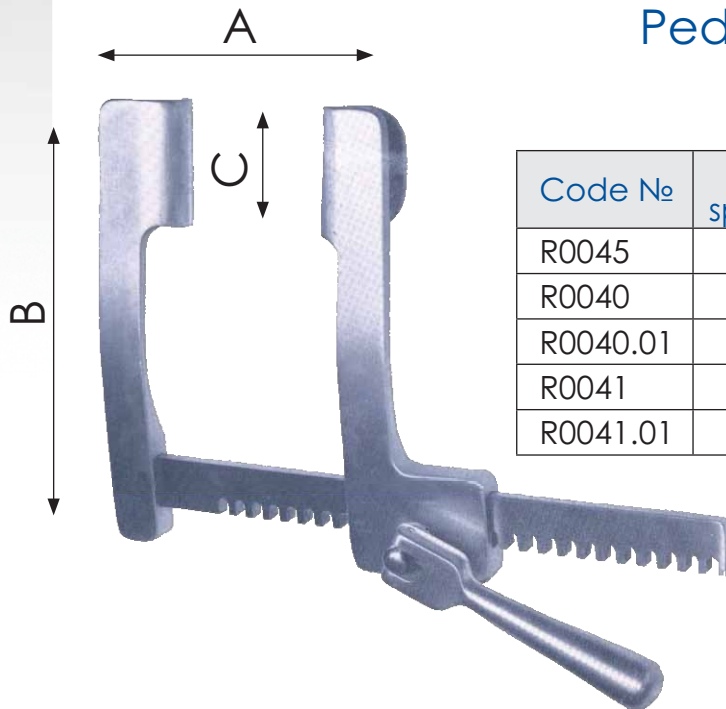

| Code № | total spread A | arm length B | blades C |
|----------|----------------|--------------|----------|
| R0045 | 30 mm | 30 mm | 15 mm |
| R0040 | 45 mm | 45 mm | 15 mm |
| R0040.01 | 45 mm | 65 mm | 35 mm |
| R0041 | 65 mm | 55 mm | 21 mm |
| R0041.01 | 80 mm | 70 mm | 36 mm |

Sterilization Cases

Titanium



G0003.05

| Code № | length | width | height | |
|----------|--------|--------|--------|-------------|
| G0003 | 370 mm | 250 mm | 40 mm | One shelf |
| G0003.05 | 370 mm | 270 mm | 50 mm | Two shelves |



G0003

Stainless Steel-TITANIUM



MEDICAL
INSTRUMENTS

12, Salikh Saidashev Str.,
Kazan, Russia, 420021

Tel.: +7 (843) 221-93-02
e-mail: pr.kmiz@mail.ru
www.kmizmarket.ru